

BEETHOVEN A415

Four-valve, plus rectifier, three-waveband superhet for AC mains of 200-250 volts, 50 cycles. Provided with PU and ES sockets. Made by Beethoven Electric Equipment, Ltd., Chase Road, London, NW10.

THE aerial when connected to socket A1 is fed direct to S1 but when connected to A2 is fed through a signal reducing resistor R1. S1 selects the aerial coupling coils L1 (LW) and L4 (MW) and feeds the aerial via capacitor C2 to grid coil L7 (SW).

Bandpass input is used on LW and MW ranges and S2 selects the input bandpass coils L2 (LW) and L5 (MW) which are tuned by VC1. T1 (LW) and T4 (MW) are bandpass trimmers.

S5 selects the grid band-pass coils L3 (LW), L6 (MW) and the short wave coil L7 to grid of V1 the frequency changer. These coils are tuned by VC2. T2 (LW), T6 (MW) and T9 (SW) are the trimmers.

AVC is fed to grid of V1 on LW and MW via R2 decoupled by C1. No AVC voltage is applied on SW. R6 decoupled by C4 provides cathode bias while screen voltage is derived from junction of R3, R4 which, with R6, from a bleeder network across HT voltage. C3 decouples the screen voltage.

L8 (SW), L9 (MW) and L10 (LW) connected in series and tuned by capacitor VC3 form the

oscillator grid circuit of V1. S5 shorts L10 and T4 (LW) when on MW and also L9, T7 (MW) when on SW to earth via S4. S4 switches T3 (LW) trimmer and T8 (MW) padder.

T10 (SW), T7 (MW) and T3 (LW) are trimmers, and T8 (MW) and T4 (LW) padders. No padding adjustments are provided on SW.

R7, C5 provide leak-condenser bias to oscillator grid. L11 is common oscillator anode reaction coil and C6 is anode coupling capacitor. HT for oscillator anode is applied via R5.

L12, T11, which from the primary of IFT1, an iron dust core IF transformer, is in the hexode anode of V1. L13 with trimmer T12, comprising the secondary of IFT1, feed the signal to grid of V2 on IF amplifier.

AVC is applied to grid V2 via R10 decoupled by C7. Cathode bias is supplied by R9 decoupled by C17. R8 decoupled by C8 provides screen voltage.

L14 with trimmer T13 from the primary of IFT2 and the secondary, comprising L15 and trimmer T14, feeds the signal diode of V3. (Note that IFT2 is not an iron core transformer.)

R21 is signal diode load and also volume control,

and R16, C11 and C12 constitute an IF filter. PU sockets are connected to top end of R21 and to chassis. The AVC diode is fed from primary of IFT2 by C9. R11 is AVC diode load.

C10 feeds the rectified signal to grid of V3 with R12 as grid resistor. R15 is the anode load and R14, C20 decouple the HT supply to V3. C14 is anode bypass capacitor. R13 provides cathode bias and negative feedback voltages.

C13 feeds the amplifier signal to grid of V4, the output valve. R18 is its grid resistor and R17 a grid stopper. R19 provides cathode bias and negative feedback voltages to V4. Screen voltage is derived from main HT line.

L16 the primary of OPI, the LS output transformer, is an anode of V4 with C15 giving a degree of fixed tone control. Secondary L17 feeds L18, a low impedance speed coil, and is joined to external speaker socket.

HT is supplied from L19 the HT secondary of MT1, the mains input transformer. V5 is a full-wave rectifier taking its filament supply from L20.

Smoothing is of the resistance-capacitance method using R20, C18 and C19. L21 supplies

Continued overleaf

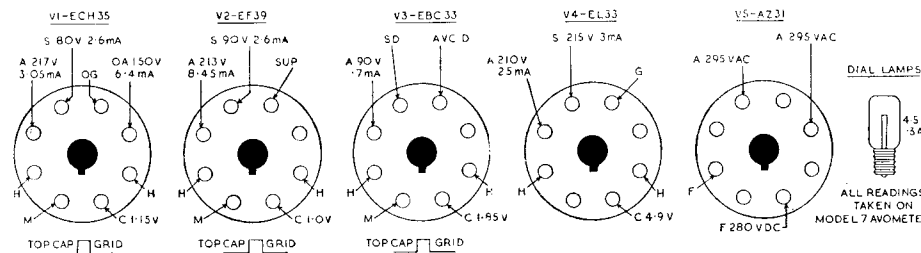

INDUCTORS

L	Ohms
1	4
2	18.5
3	18.5
4	1.2
5	3.5
6	3.5
7	Very low
8	Very low
9	4.5
10	8
11	Very low
12	3.8
13	3.8
14	8.75
15	8.75
16	225
17	Very low
18	Very low
19	1,300
20	Very low
21	Very low
22	35

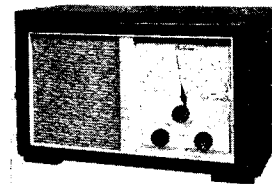

RESISTORS

R	Ohms
1	22 K
2	1.2 Meg
3	33 K
4	47 K
5	10 K
6	100
7	47 K
8	47 K
9	100
10	1.2 Meg
11	1.2 Meg
12	470 K
13	3.3 K
14	22 K
15	150 K
16	33 K
17	180 K
18	470 K
19	180
20	1.2 K
21	.5 Meg Potentiometer

CAPACITORS

C	Mfds
1	.1 Tubular 350V
2	50pf Silver Mica
3	.01 Tubular 1000V
4	.01 Tubular 1000V
5	100 pf Silver Mica
6	.01 Tubular 1000V
7	.1 Tubular 350V
8	.1 Tubular 350V
9	5 pf Ceramic
10	.05 Tubular 350V
11	150 pf Silver Mica
12	150 pf Silver Mica
13	.05 Tubular 500V
14	100 pf Silver Mica
15	.002 Tubular 1000V
16	.01 Tubular 1000V

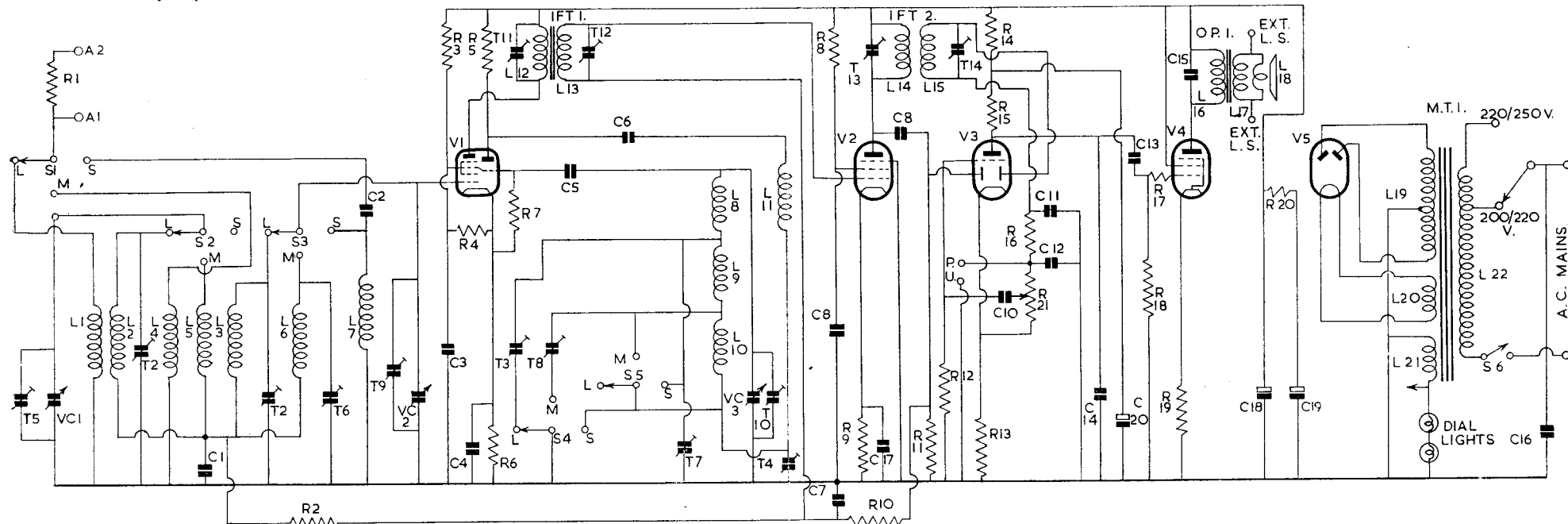

BEETHOVEN A415—Contd.

filaments of V1—V4 and also the dial lights, which are connected in series across L21.

L22 the primary of MT1 is tapped to cover input voltages of 200—220 volts and 220—250 volts. S6 which is controlled by spindle of volume control is the on/off switch and C16 a mains supply filter capacitor.

TRIMMING INSTRUCTIONS

Apply signal as below	Tune Receiver to	Adjust in order stated for max. output
(1) 450.5 KC to top cap of V1 via .01	550 metres	T14, T13, T12 and T11
(2) 19 MC. As in (1)	19 MC	T10
(3) 1,500 KC. As in (1)	200 metres	T7
(4) 250 KC. As in (1)	1,200 metres	T3
(5) 160 KC. As in (1)	1,875 metres	T4. Repeat (4) and adjust T3 if necessary
(6) 600 KC. As in (1)	500 metres	T8. Repeat (3) and adjust T7 if necessary
(7) 6 MC to A1 socket via a dummy aerial	50 metres	T9
(8) 1,300 KC. As in (7)	234 metres	T6, T5
(9) 250 KC. As in (7)	1,200 metres	T2, T1
(10) 160 KC. As in (7)	1,875 metres	Check T4 and adjust if necessary
(11) 600 KC. As in (7)	500 metres	Check T8 and adjust if necessary

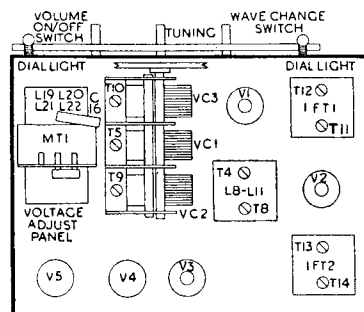
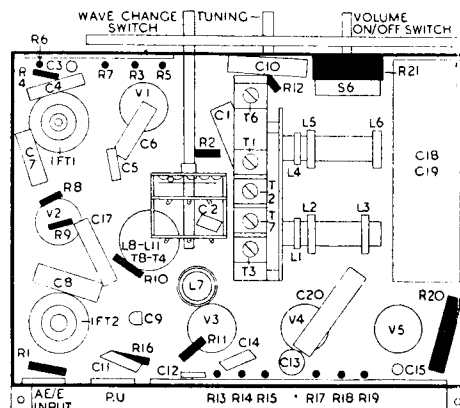

Above: Chassis layouts. Below: Left, switch wafer connections. Right: Output transformer connections.

SWITCH WAFERS VIEWED FROM REAR OF INVERTED CHASSIS

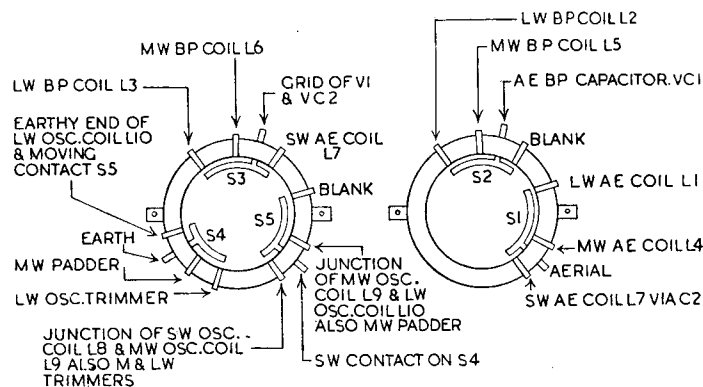

REAR SECTION

FRONT SECTION

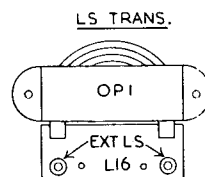

GET YOUR SHOWCARDS NOW

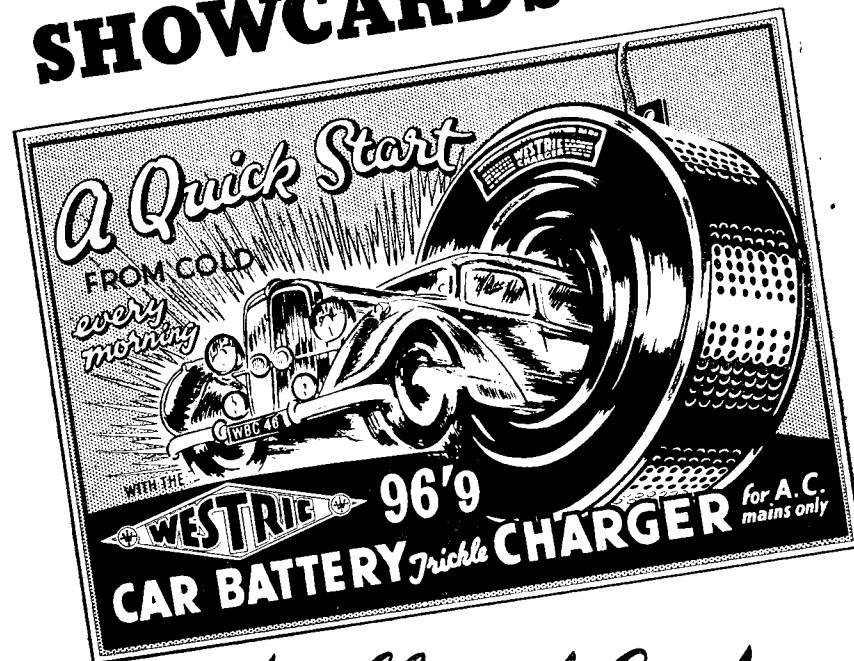

and sell and fit the



CAR BATTERY TRICKLE CHARGER

Immediate supplies of showcards and literature are now available free of charge. Delivery of the "Westric" is ex stock. Liberal trade discounts.

DEPT. E.Tr. WESTINGHOUSE BRAKE & SIGNAL CO. LTD., 82, YORK WAY, KING'S CROSS, LONDON, N.1