

# PHILCO D521 EMPIRE AUTOMATIC

**A**UTOMATIC tuning is provided by a telephone-type dial. There are seven finger-holes in a circular dial. When a finger is inserted to turn the dial a button is pressed so that a stud catches in a slot in a back plate and arrests the dial at the required point.

The exact dial position is adjusted by means of a screw set in the centre of each button. This screw rotates a short arm which carries the catch stud. The buttons rotate slightly, but act only as a locking device for the adjustment screws.

A novel point is that tuning circuit constants are chosen so that the set can be aligned to ensure that three buttons each provide both medium and long wave programmes.

**CIRCUIT.**—Aerial input to the signal grid of V1, a 6A7 frequency changer, is *via* a choke-coupled circuit to single-tuned circuits on both medium and long bands. The oscillator circuit will be recognised as a modified Hartley arrangement with single coils acting as both grid and regeneration windings.

V1 is coupled *via* an I.F. transformer, tuned to 475 kc., to the I.F. amplifier V2, a 78E pentode. Another transformer effects the coupling between V2 and the demodulating diode of V3, an 85 double diode triode. The other diode of V3, fed by a coupling condenser C10, provides a

D.C. potential for automatic volume control.

The manual volume control of the receiver, fed through an H.F. stopper resistance R19, also constitutes the demodulating diode load.

V3 is resistance capacity coupled to V4, a 42E output pentode. A pentode compensator condenser is connected between anode and cathode. Two resistances connected between the H.T. negative centre tap and the chassis earth line provide bias for the valves.

Mains equipment consists of a transformer, a type 80 full-wave rectifying valve V5, electrolytic smoothing condensers and a smoothing choke (the speaker field). Mains suppressor condensers are connected across the primary of the transformer.

**Chassis Removal.**—Remove the back of the cabinet (secured by five metal screws), the three spring-fixed control knobs, and the combined chassis-securing bolts and cabinet feet. The chassis may then be completely withdrawn from the cabinet.

**Special Notes.**—The single dial light illuminates a rectangular slot that performs the operation of a pointer. The bulb has a bayonet-type base and is rated at 6.3 volts .35 amp.



The D521 "Empire Automatic" by Philco is a five-valve two-band A.C. superhet employing precision-made telephone-dial type automatic tuning.

Two sockets on the internal speaker panel are for connecting an extension speaker. This should be of the permanent-magnet type with an impedance of some 2 to 3 ohms.

C15 and C16 are contained inside I.F.T.1, and C17, C18 and R19 are contained in I.F.T.2. In our particular

## VALVE READINGS

No signal. Volume maximum. M.W. min. cap 230 volt. A.C. mains.

V.	Type.	Electrode.	Volts.
1	(All Philco) 6A7	Anode ..	250
		Screen ..	85
		Osc.anode ..	180
2	78E	Anode ..	250
		Screen ..	85
3	85	Anode ..	50
4	42E	Anode ..	235
		Screen ..	250
5	80	Heater ..	350

## RESISTANCES

R.	Purpose.	Ohms.
1	V1 A.V.C. decoupling ..	99,000
2	V1 and V2 screens decoupling ..	160,000
3	V1 and V2 screens decoupling ..	51,000
4	Osc. anode load ..	20,000
5	Osc. grid leak ..	99,000
6	A.V.C. line decoupling ..	1.5 meg.
7	V3 cathode bias ..	6,000
8	A.V.C. diode load ..	1.5 meg.
9	V3 anode load ..	100,000
10	Bias potentiometer (part) ..	63
11	Bias potentiometer (part) ..	200
12	V4 grid leak ..	400,000
19	H.F. stopper ..	51,000
VR1	Volume control ..	500,000

## CONDENSERS

C.	Purpose.	Mfds.
1	V2 grid decoupling ..	.01
2	Aerial coupling ..	.0067
3	Aerial padder ..	.00225
4	H.T. line by-pass ..	.25
5	Medium wave osc. fixed padder ..	.00025
6	Osc. anode coupling ..	.0008
7	M.W. osc. fixed trimmer ..	.00015
9	V1 and V2 screens decoupling ..	.05 + .05
10	A.V.C. diode coupling ..	.00011
11	I.F. coupling ..	.03
12	V3 anode H.F. by-pass ..	.0065
13	Mains suppressors ..	.015 + .015
14	Pentode compensator ..	.0025
15	I.F.T.1 prim. fixed trimmer ..	.000115
16	I.F.T.1 sec. fixed trimmer ..	.00005
17	H.F. by-pass ..	.00011
18	H.F. by-pass ..	.00011
EC1	Bias pot. shunt ..	.35
EC2	H.T. smoothing ..	8 + 8

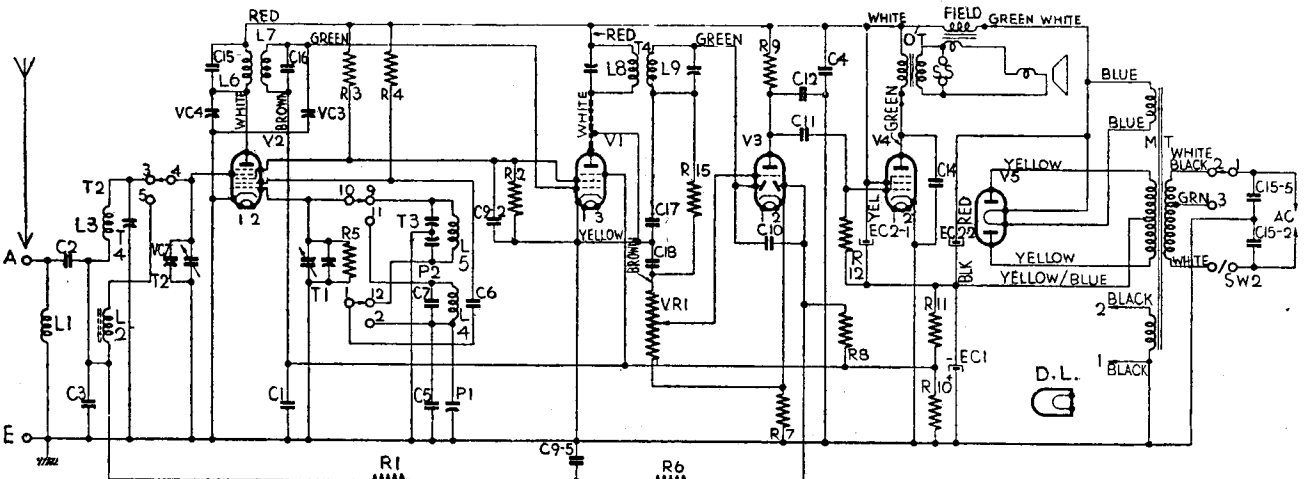

A conventional circuit is employed, the automatic tuning being solely mechanical. Bias is obtained from resistors in the negative H.T. line.

chassis a small condenser was connected between L5 and the wavechange switch.

### Circuit Alignment Notes

**I.F. Circuits.**—Connect an output meter across the primary of the speaker transformer. Switch receiver to M.W. band, turn gang to maximum capacity and volume to maximum. Connect a service oscillator between the top grid cap of V1 and chassis, leaving grid connection made.

Tune the service oscillator to 457 kc. and adjust the trimmers of I.F.T.2 and then I.F.T.1 for maximum, reducing the input from the oscillator as the circuits come into line so as to keep the A.V.C. inoperative.

**Signal Circuits.**—To adjust dial, open gang to fullest extent, insert a .006 feeler gauge under the heel of the moving vanes, and close tuning condenser on to gauge when the indicator should read on index point (under letter "a" in word "Lenin-grad"). Feeler gauge should then be removed.

Connect the service oscillator to the A. and E. sockets via a dummy aerial, only feeding sufficient input to obtain reliable peaks in the output meter.

**Medium Waves.**—Tune set and oscillator to 214 metres (1,400 kc.). This is marked by a dot on dial. Adjust T1 and then T2 for maximum.

Tune oscillator to 500 metres (600 kc.),

## Empire Automatic on Test

**MODEL D521.**—Standard model for A.C. mains, 200-250 volts, 50-100 cycles. Price 8½ gns.

**DESCRIPTION.**—Four-valve, plus rectifier, two-band table type superhet, employing automatic tuning.

**FEATURES.**—Full-vision scale calibrated in station names and metres. Telephone-type dial with seven press buttons. "Bumper" provided at end of travel to prevent distortion of gang when using dial buttons. Manual tuning control provided. Other controls for wave selection and combined volume and master switch. Sockets on speaker panel for extension speaker.

**LOADING.**—48 watts.

### Sensitivity and Selectivity

**MEDIUM WAVES** (200-550 metres).—Excellent sensitivity and adequate selectivity, local stations spreading on

adjacent channels. Gain well maintained over the band.

**LONG WAVES** (1,100-1,900 metres).—Similar performance to medium wave band. All main stations easily received. Only slight interference on Deutschlandsender, which is good for two-circuit tuner.

### Acoustic Output

Well-balanced tone, with crisp, clean attack and generally pleasing reproduction on speech and music.

### Automatic Tuning

As received, the adjustment of the press-buttons was excellent. A very good feature is the alignment of the set so that two stations, medium and long wave, are provided by one button. The seven buttons give ten stations. The condenser "buffer" is also a good point.

Construction is excellent and highly accurate to prevent backlash.

tune in on receiver and adjust P1 for maximum, simultaneously rocking the gang.

Repeat both operations until no further improvement results.

**Long Waves.**—With wavechange switch in M.W. position, feed in and tune a 285.7 metres (1,050 kc.) signal—this corresponds to West Regional. Keep dial in this position, switch set to L.W. band

and feed a 1,293 metres (232 kc.) signal—this corresponds to Luxembourg—and adjust T3 and then T4 for maximum.

Tune oscillator to 160 kc., tune in on (Continued on page 24)

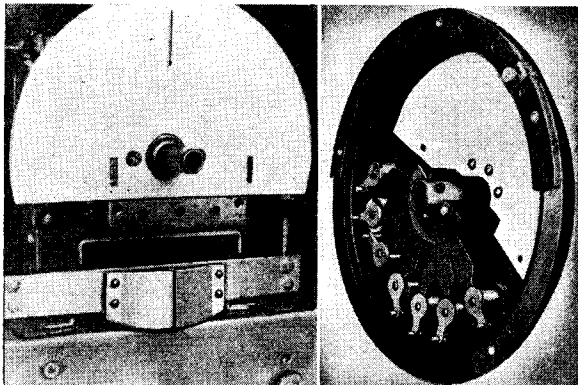

The pictures clearly show the studs on the dial "fingers" (right) and the slot with which they co-operate (left).

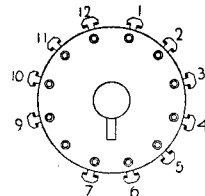

### WINDINGS (D.C. Resistances)

Windings.	Ohms.	Range.	Measured between.
L1 .. ..	25	Any	A socket and chassis.
L2 .. ..	3.5	Any	Across tags.
L3 .. ..	45	Any	Across tags.
L4 .. ..	5	Any	Across tags.
L5 .. ..	25	Any	Across C7.
L6 .. ..	8	Any	I.F.T.1 white and red wires.
L7 .. ..	12	Any	I.F.T.1 brown wire and top grid V2.
L8 .. ..	12	Any	I.F.T.2 white and red leads.
L9 .. ..	X	Any	Inaccessible.
O.T. prim.	500	Any	Spkr. panel—white and green leads.
Field ..	1,140	Any	Spkr. panel—green / white and white leads.
M.T. prim.	20 & 18	Any	Common and two tappings.
Total H.T. sec.	480	Any	V5—pins 3 and 4

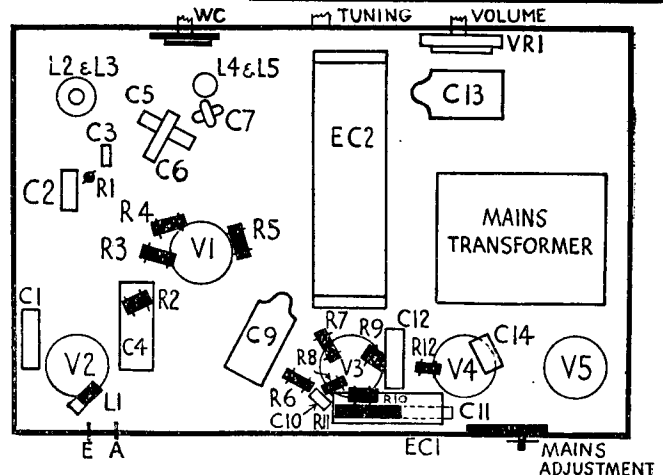
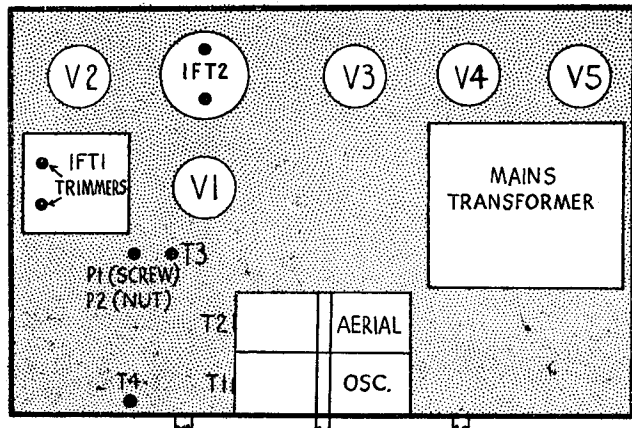

Above are the chassis layout diagrams which show orderly, logical layout. The switch diagram has the contacts numbered corresponding to the circuit diagram.

# Pilot U106 Six-Band

(Continued from page 23)

turn gang to maximum and tone controls to "high" position.

Connect a service oscillator via a .1 mfd. condenser to the top grid cap of V5 and chassis. Tune oscillator to 456 kc. and adjust the trimmers of I.F.T.3 for maximum response. Only feed sufficient input from the service oscillator to obtain definite peaks in the output meter, so as to prevent operation of the A.V.C.

Connect the service oscillator to the top grid cap of V4, adjust the trimmers of I.F.T.2, then connect the oscillator to the top grid cap of V2 and adjust the trimmers of I.F.T.1 for maximum.

**Signal Circuits.**—Connect the service oscillator to the A and E terminals of the receiver, only feeding sufficient input to obtain reliable peaks. Make sure that the metal connecting bar is between the E. and A2 terminals.

**Long Waves.**—Tune set and oscillator to 800 metres (375 kc.) and adjust T1, T2 and then T3 for maximum.

Tune oscillator to 2,000 metres (150 kc.), tune in on receiver, then adjust P1 for maximum, simultaneously rocking the gang.

Re-check at 800 metres.

**Medium Waves.**—Tune set and oscillator to 200 metres (1,500 kc.) and adjust T4, T5 and then T6 for maximum.

Tune oscillator to 500 metres (600 kc.), tune in on receiver, then adjust P2 for

This diagram (right) enables all parts on the top of the U106 chassis to be identified. Below, is the bank on the front of the band switch which controls the dial lights. Wave switch diagrams are not given because of the inaccessibility of the tuning pack.

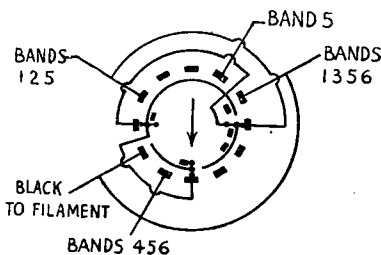
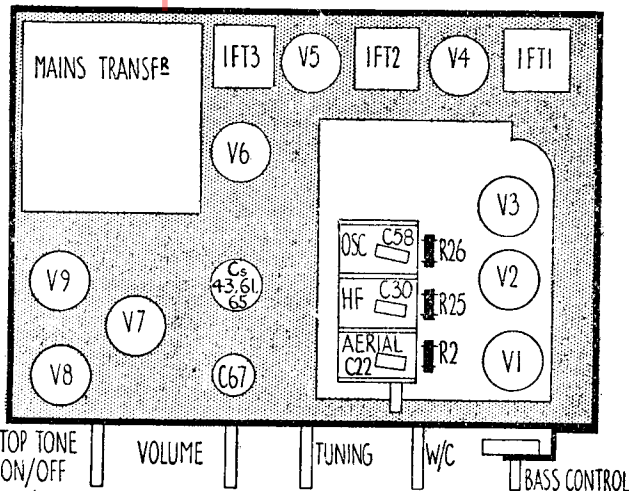

maximum, simultaneously rocking the gang.

Re-check at 200 metres.

**Short Waves.**—Band 4. Tune set and oscillator to 70 metres (4.3 mc.) and adjust T7, T8 and T9 for maximum response, simultaneously rocking the gang.

Band 3. Tune set and oscillator to 27 metres (11.1 mc.) and adjust T10, T11, and then T12 for maximum response, simultaneously rocking the gang.

Band 2. Tune set and oscillator to 13 metres (23,077 kc.) and adjust T13, T14 and then T15 for maximum response, simultaneously rocking the gang.

Band 1. Tune set and oscillator to 5 metres (60 mc.) and adjust T16 for maximum.

### Replacement Condensers.

Exact replacement condensers for the U106 available from A. H. Hunt, Ltd., Garratt Lane, Wandsworth, London, S.W.18, are: For either C42 or C58, unit number 2985, price 1s 4d.; for C67, 3540, 7s. 6d.; for the block containing C43, C61 and C66, unit 4112 8s.; and for C66, 2632, 2s. 6d.

move, by means of a pin, the name-tag of the button and inset the prongs of the special tool provided into the two holes in the centre of the button. Press the button and rotate the dial (both ways) until the button engages with the slot behind dial, then rotate the special tool one turn counter-clockwise sufficient to loosen button, but not beyond this.

Still keeping button depressed, take out the tool and insert the blade into the centre of the button. Turn this screw, which will rotate the dial, until the desired station is again tuned in. Then, keeping the blade of the tool pressed in and held steady with one hand, tighten the button by clockwise rotation with finger and thumb of other hand. Then insert the appropriate name-tag.

# Pye 802 A.C. Five

(Continued from page 27.)

if necessary to prevent the valve oscillating.

Tune service oscillator to 465 kc. and adjust the outer coils only of the I.F. transformers with an insulated spacer tool until a maximum peak is obtained in the output meter. After adjustment re-seal the coils with ordinary coil dope and if possible leave for approximately two hours to dry before carrying out any signal trimmer adjustments.

**Signal Circuits.**—Connect the service oscillator to the A. and E. sockets via a dummy aerial, only feeding sufficient input to obtain reliable peaks in the output meter so as to keep the A.V.C. inoperative.

**Short Waves.**—Tune set and oscillator to 15 metres (20 mc.) and adjust T1 for maximum.

Inject a 50 metres (6 mc.) signal and tune in on receiver. The oscillator circuit must be adjusted to make the calibration correct in moving the lead to the oscillator section of the gang in relation to the short wave winding on the oscillator coil.

Similarly the aerial circuit must then be adjusted for optimum signal strength by moving the black lead to the S.W. aerial coil in relation to this winding. (Note that the gang must be retuned each time a lead is moved.) If much adjustment is required repeat the trimming adjustment at 15 metres.

**Medium Waves.**—Tune set and oscillator to 210 metres (1,425 kc.) and adjust T2 and then T3 for maximum.

The medium wave calibration is fixed, but check at 500 metres (600 kc.), and if necessary compensate with T2 afterwards retrimming T3 on a 210 metres signal.

**Long Waves.**—Tune set and oscillator to 1,800 metres and adjust P1 for maximum, simultaneously rocking the gang.

### Replacement Condensers

Exact replacement condensers for the Pye 802 are made by A. H. Hunt, Ltd. These are: For the block containing C34 and C35, unit 3990, price 9s. 3d.; for C18, 4049, 1s. 9d.; for C33, 2935, 1s. 9d.; and for C27, 4015, 1s. 6d.

## VALVE READINGS

Screen and anode voltages measured to cathode.

V.	Type.	Electrode.	Volts.
1	6U7G	Anode .. .. .	216
		Heaters .. .. .	6.3
		Screen .. .. .	94
2	6L7G	Anode .. .. .	228
		Heaters .. .. .	6.3
		Screen .. .. .	94
3	6J7G	Anode .. .. .	170
		Heaters .. .. .	6.3
4	6U7G	Anode .. .. .	224
		Heaters .. .. .	6.3
		Screen .. .. .	94
5	6A8G	Anode .. .. .	222
		Cathode .. .. .	3.7
		Heaters .. .. .	6.3
		Screen .. .. .	94
6	6Q7G	Anode .. .. .	180
		Cathode .. .. .	43
		Heaters .. .. .	6.3
7	6N6G	Anode .. .. .	350
& 8		Heaters .. .. .	6.3
9	SU46	Driver anode ..	305
		Unsmoothed D.C. ..	420

# Philco D521 Empire Automatic

(Continued from page 33.)

receiver (corresponding to dot under letter "t" in word "Budapest") and adjust P2 for maximum, simultaneously rocking the gang.

Repeat until no further improvement results.

**Automatic Buttons.**—The receiver is sent out adjusted to receive a selected number of stations. If a station not mentioned on the button name tags is desired, then the button nearest the slot (at the back of the dial) when the station is tuned in should be used.

With the desired station tuned in, re-