

AMBASSADOR 548

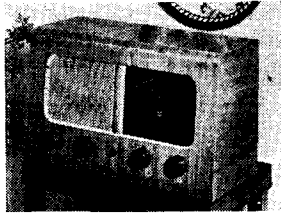

Five-valve, 3-waveband superhet with internal frame aerial. Provision for external aerial and earth, pickup and low-impedance extension speaker. Designed for 200-250V 50 c/s AC mains. Walnut veneered cabinet. Made by R. N. Fitton, Ltd., Brighouse, Yorkshire.

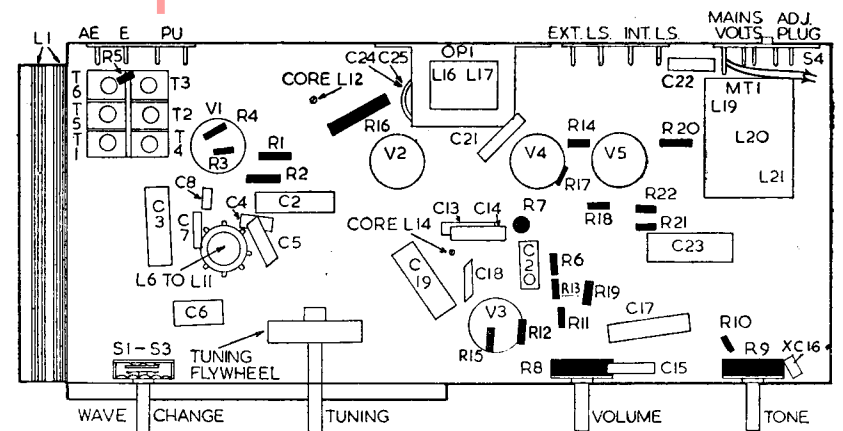
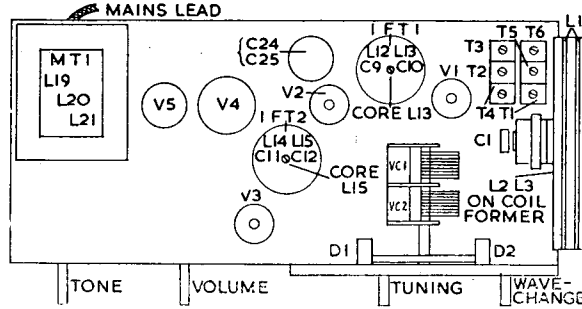

CIRCUIT consists of a triode-hexode frequency-changer V1 coupled by a permeability-tuned IF transformer to a variable- μ IF amplifier V2, which, in turn, is coupled by a second permeability-tuned IF transformer to a double-diode triode V3 used for signal rectification, AVC and AF amplification. V3 is resistance-capacity coupled to an output pentode V4 which feeds an 8in. PM loud-speaker. Negative feedback from secondary of output matching transformer is applied to cathode circuit of V3.

Aerial. The input circuit is of rather unusual design. When an external aerial is used the signal is fed to series connected coupling coils L3, L2. On SW band L3 provides fairly close coupling to SW grid tuned coil L5 and on LW band L2 couples signal to grid tuned coil L4, these coils all being wound on the same former. On MW band L2 and L3 provide loose coupling to tuned frame L1.

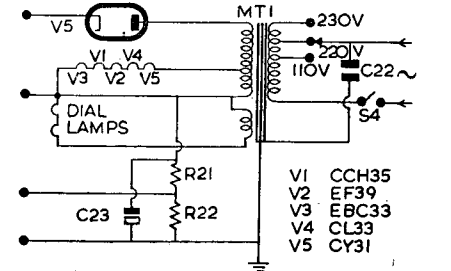
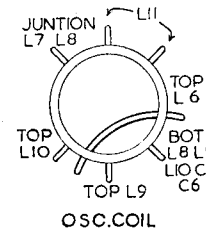
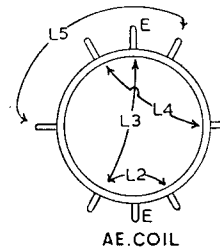

Continued overleaf

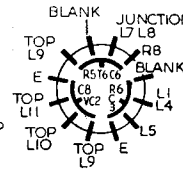
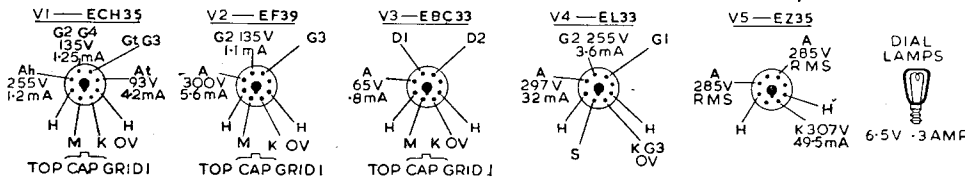

BIAS DEVELOPED ACROSS R21 R22 = 6.4V

RESISTORS

R	Ohms	Watts
1	47K	
2	39K	
3	33	
4	22K	
5	47K	
6	2.2M	
7	47K	
8	500K Potentiometer	
9	1M Potentiometer	
10	2.2M	
11	1M	
12	22	
13	1M	
14	100K	
15	220K	
16	3.3K	
17	220K	
18	470K	
19	100	
20	150	
21	91	
22	39	

C	Capacity	Type
11	60 pf silver mica	
12	140 pf silver mica	
13	120 pf mica	
14	120 pf mica	
15	.01 tubular 1000V	
16	300 pf mica	
17	.1 tubular 500V	
18	15 pf silver mica	
19	.1 tubular 500V	
20	.04 tubular 500V	
21	.01 tubular 500V	
22	.005 tubular 1000V	
23	50 electrolytic 12V	
24	16 electrolytic 450V	
25	16 electrolytic 450V	

INDUCTORS

L	Ohms
1	2.5
2	11
3	.25
4	11
5, 11, 20	Very low

CAPACITORS

C	Capacity	Type
1	300 pf mica	
2	.1 tubular 300V	
3	.1 tubular 500V	
4	6000 pf mica	
5	625 pf silver mica	
6	300 pf silver mica	
7	120 pf mica	
8	120 pf mica	
9	100 pf silver mica	
10	100 pf silver mica	

6	.8 total
7	
8	
9	2.5
10	2
12, 13	6
14	7.5
15	5.5
16	175 total
17	.4
18	3
19	400
21	60 total

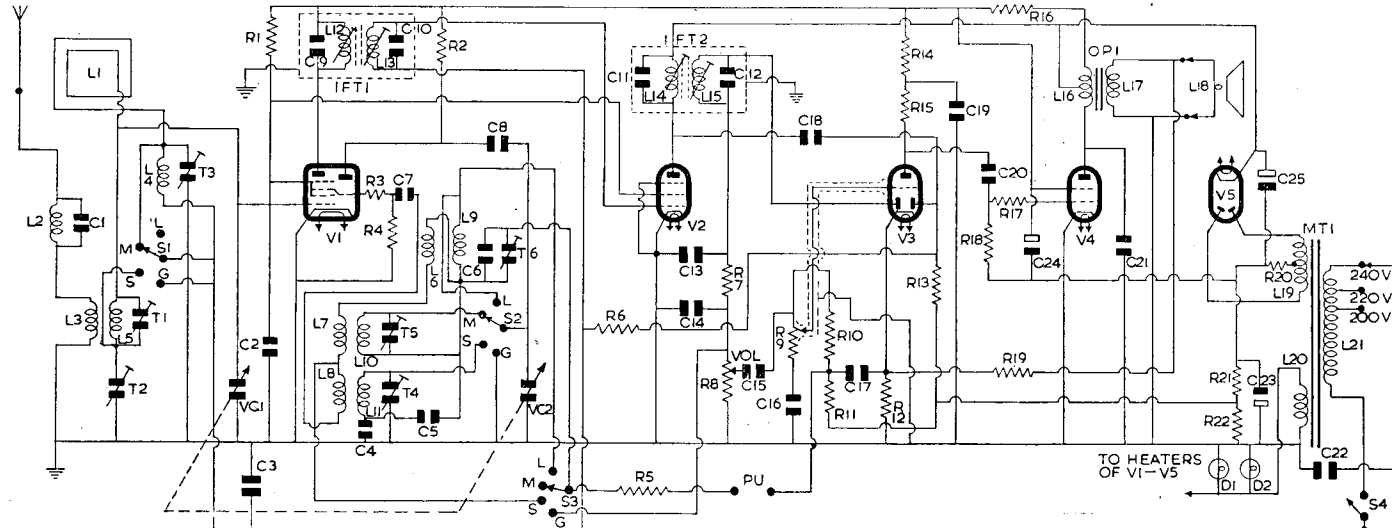

AMBASSADOR 548—Contd.

C1 connected across L2 is coupling by-pass capacitor.

L5 (SW), L1 (MW) and L4 (LW), the grid coils, are connected to V1 and to tuning capacitor VC1.

T1 (SW), T2 (MW) and T3 (LW) are trimmers. AVC is applied to V1, on all wavebands, from R6 decoupled by C3. S1 short circuits L4 when in MW position and connects AVC line to bottom end of L5 when switched to SW. In "Gram" position the AVC line is connected down to chassis.

Cathode of V1 is at chassis potential and standing bias is obtained from AVC diode delay voltage, which is fed through R6 to V1. Screen voltage is obtained from R1 decoupled by C2. L12, C9, which form the primary of IFT1, are in the hexode anode circuit.

Oscillator is connected in a tuned-anode parallel-fed HT circuit. L11 (SW), L10 (MW) and L9 (LW) are the anode coils and S2 connects them to tuning capacitor VC2. T4 (SW), T5 (MW), C6, T6 (LW) are trimmers and C4, C5 padders. LW trimmers C6, T6 are connected across L9 only when S3 is switched to LW position.

C8 is anode coupling capacitor and R2 oscillator anode load. S2 earths oscillator anode through C8 when switched to gram position.

The grid coils L8 (SW), L7 (MW) and L6 (LW) are series connected and coupled to oscillator grid through C7. When S3 is in the SW position then L6 (LW) and L7 (MW) are shunted by LW trimmers C6, T6. Self bias for oscillator grid is provided by R4, C7. R3 is grid stopper resistor.

IF amplifier operates at 452 kc/s. L13, C10, the secondary of IFT1, feeds signal to grid of V2. AVC and standing bias are fed through L13 to grid from R6 decoupled by C3. Cathode is connected down to chassis. Screen voltage is obtained from R1 decoupled by C2. Suppressor grid is strapped to cathode. L14, C11, the primary of IFT2, is in the anode circuit of V2.

Signal rectifier. L15, C12, the secondary of IFT2, feeds signal to one diode of V3. R8, the volume control, is the diode load and R7, C13, C14 form an IF filter.

Pickup. Output from pickup is fed through R5 to S3 to volume control R8. The earthy side of pickup is connected to bottom end of grid resistor R10 of V3 and to bias feed resistor R11. If the screening of pickup lead is used as one side of signal circuit it must, on no account, be connected down to chassis or earth, otherwise negative bias to grid of V3 will be short circuited.

Automatic volume control. C18 feeds signal from primary L14 of IFT2 to second diode of V3. R13 is diode load and R6 feed resistor. C3 is AVC line decoupling capacitor. Delay voltage for AVC diode is obtained by returning bottom end of load resistor R13 to junction of R21, R22, which are in the HT negative lead to chassis. The delay voltage is also fed to grids of V1 and V2 and provides standing bias for these valves.

AF amplifier C15 feeds signal from R8, the volume control, to tone control network, R9, C16, and thence to grid of V3. R10 is its grid resistor and grid bias is obtained by connecting R10 to bias network, R21, R22. R11, C17 decouple bias voltage to grid of V3.

Negative feedback from secondary L17 of output matching transformer is fed by R19 to R12 in the cathode circuit of V3. R15 is V3 anode load

resistor and R14, C19 decouple HT supply to this valve.

Output stage. C20 feeds signal to grid of output pentode V4. R18 is grid resistor and R17 grid stopper. Cathode is connected down to chassis and bias for grid is obtained from R21, R22 decoupled by C23. Screen voltage is obtained from R16 decoupled by C24. HT for anode V4 is obtained direct from reservoir capacitor C25 and is fed to tapping on primary L16 of output matching transformer OP1. The opposite phased currents developed in L16 provide hum cancellation. C21 provides tone correction.

L17, the secondary of OP1, feeds signal to L18, an 8-in. PM loudspeaker, and also provides negative feedback for cathode of V3. Sockets are fitted for connection of low-impedance external speaker.

High tension is provided by an indirectly heated full-wave rectifier V5. L19, the HT secondary of MT1, the mains input transformer, supplies its anode voltages. Its heater current is obtained from L20, which supplies heaters V1 to V4. Smoothing is provided by C24, C25, R16 and part of L16. R20 is limiter resistor in anode circuit of rectifier.

R21, R22 in the negative return to chassis provide bias for grids of V1 to V4 and AVC delay voltage. C23 is decoupling capacitor.

Heaters of V1 to V5 and dial lights obtain their current from secondary L20 of MT1. Primary L21 of MT1 is tapped for input voltages of 200 to 250V 50 c/s. C22 is mains filter capacitor and S4 mains ON/OFF switch.

Chassis removal. Remove the four push-on control knobs and rear panel of cabinet. Unplug internal loudspeaker leads from sockets at rear of chassis. Unscrew the four chassis bolts on underside of cabinet. Chassis can be withdrawn.

To replace cord drive. Remove dial plate and pointer. With front of chassis facing operator, adjust drive drum so that semi-circular slot is vertical, and also that drum is in the centre of slot on chassis with the gang vanes fully in. Thread one end of a 20-in. length of drive cord through the hole in the rim of the drum. Loop the end of the cord and slip this over gang spindle. Take the other end of the cord in an anti-clockwise direction round the drum and 1½ times round the drive spindle. Thread the end of the cord back through the hole in drum and attach spring, which is then placed over hook on drum.

When finished the spring should be slightly less than 1½ times its normal length.

NOTE.—Later models of this receiver are fitted with AC/DC valves operated from an isolating transformer with a primary tapped for 110, 220 and 230V 50-100 c/s mains input. The modified power supply circuit is shown.

TRIMMING INSTRUCTIONS

Apply signals as stated below	Tune Receiver to	Trim in Order stated for Max. Output
(1) 452 kc/s to gl of V1 via .01 mF.	Gang condenser at max. capacity	Core of L15, L14 L13, L12
(2) 15 mc/s to AE socket via a dummy aerial	20 metres	T4, T1
(3) 1.2 mc/s as above	250 metres	T5, T2
(4) 250 kc/s as above	1,200 metres	T6, T3

Insulation+Continuity with one instrument

The Everett Edgcombe Hum-Metrohm Insulation Tester is an instrument with three positive advantages.

1. It can be operated with one hand, leaving the other free to manipulate the connections.
 2. Combines a 500 volt insulation and earth circuit conductivity test in a single instrument.
 3. Ripple-free testing current facilitates insulation measurements on condensers.
- Both regular and occasional users of insulation testing sets will find these three advantages of real value.

Full details gladly sent on request.

Ask for catalogue sheet 242F.



THE HUM - METROHM

MAKERS OF ELECTRICAL INSTRUMENTS FOR INDICATING, RECORDING AND CONTROLLING, PHOTOMETRIC APPARATUS AND PROCESS CONTROLS.

COLINDALE WORKS, LONDON, N.W.9
Tel.: COLindale 6045

DHB



"SOUND" ADVICE FROM

MAGNETA

TRADE MARK



- AUDIO AMPLIFIERS
- RADIO AMPLIFIERS
- MICROPHONES
- LOUDSPEAKERS

No installation of Public Address Equipment for civic functions, sports meetings, etc., is too large for you with the help of Magneta technicians.

Write for details of our Dealer Assistance Plan.

THE MAGNETA TIME CO. LTD.
(SOUND DIVISION)
GOBLIN WORKS, LEATHERHEAD, SURREY