

"TRADER" SERVICE SHEET
853

EKCO A33 "RADIOTIME"

CLOCK-CONTROLLED SUPERHET



SIX pre-set stations are selected by a rotary control in the Ekco A33, with the additional feature of "Radiotime" programme switching, operated by a frequency-controlled electric clock which can be used to provide a morning alarm or switch on a given programme during the day.

Provision is made against the contingency of the transmission breaking down, or an alarm call too early for a broadcast transmission, by the inclusion of a tone alarm which takes its place. When a transmission is received, the tone alarm is automatically muted by it.

The receiver is a 3-valve (plus rectifier) superhet, with no manual tuning, designed

for use on frequency-controlled A.C. mains only, of 200-250 V, 50 c/s.

Release date and original price: May, 1947; £24 3s. plus purchase tax.

CIRCUIT DESCRIPTION

On M.W. aerial input is via tapped frame aerial **L2**, tuned by one of the pre-set trimmer type capacitors **C30-C34**, selected by switches **S4-S8**, with the addition of coupling and "loading" coils **L1, L3** on L.W., tuned by **C35**, via **S9**. I.F. rejection by **L4, C2**.

First valve (**V1**, Mullard metallized **ECH35**) is a triode-hexode operating as frequency changer with internal coupling. A Colpitts oscillator is employed, with iron-dust cored pre-set coils **L5-L10**, tuned by **C12, C13** in series, with parallel trimming by **C9**. Selection is achieved by switches **S10, S11** to **S20, S21**.

Second valve (**V2**, Mullard metallized **EF39**) is a variable-mu R.F. pentode operating as I.F. amplifier with tuned transformer couplings, or as an "alarm" oscillator. Switch **S22** closes to mute **V2** between "rest" positions of the station selector control, so that switching noises are suppressed.

Intermediate frequency 465 kc/s.

A Colpitts oscillator circuit **L16, S23, C15, C16**, tuned to approximately 300 c/s, is connected between control grid and screen grid of this valve, and in the absence of an I.F. signal to produce A.V.C. bias, oscillation takes place, but may be silenced by opening **S23**. The oscillation output at **V2** screen is coupled to **V3** C.G. circuit, via **C22**.

Diode second detector is part of double diode pentode output valve (**V3**, Mullard **EBL21**). Audio frequency component in rectified output is developed across diode load resistor **R9** and passed via A.F. coupling capacitor **C24**, manual volume control **R10**, and grid stopper **R11**, to C.G. of pentode section, which operates as A.F. amplifier. I.F. filtering by **C20, R7, C21** in diode circuit.

Second diode of **V3**, fed from **L14** via **C25**, provides D.C. potentials which are used for A.V.C. purposes. Fixed G.B. for **V3** pentode section, and A.V.C. delay voltage, are obtained from the drop across **R12, R13** in the cathode lead to chassis, and fixed G.B. for **V1, V2** is provided, via **R14**, from the drop across **R16** in the H.T. negative lead to chassis.

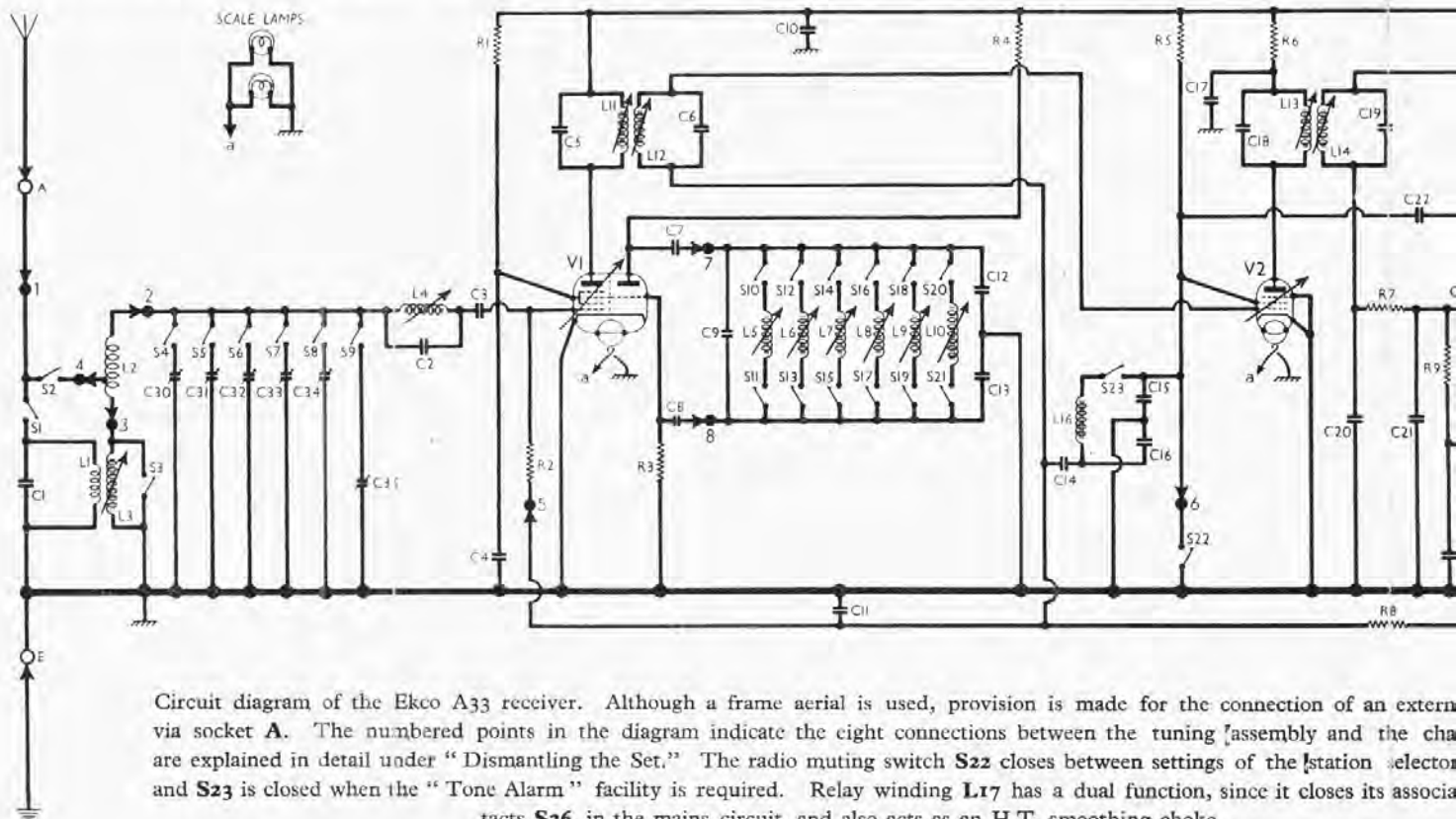

Circuit diagram of the Ekco A33 receiver. Although a frame aerial is used, provision is made for the connection of an external aerial via socket **A**. The numbered points in the diagram indicate the eight connections between the tuning assembly and the chassis. These are explained in detail under "Dismantling the Set." The radio muting switch **S22** closes between settings of the station selector control, and **S23** is closed when the "Tone Alarm" facility is required. Relay winding **L17** has a dual function, since it closes its associated contacts **S26**, in the mains circuit, and also acts as an H.T. smoothing choke.

Voltages developed across the feed-back winding **d, c**, of the output transformer **T1** are applied to the potential divider **R17, R18, C27**, tapped off, and fed back to **V3** C.G. circuit in positive phase to give bass boost.

H.T. current is supplied by I.H.C. full-wave rectifying valve (**V4, Mullard EZ35**). Smoothing by relay winding **L17**, in series with **R16**, and electrolytic capacitors **C28, C29**. All valve heaters, together with scale lamps, are fed from a single winding on the mains transformer **T2**.

For normal manual operation, the "Radio/Alarm" lever is set to "Radio", closing **S27**, so that **S28** switches the set on and off as required.

For "Radiotime" operation, the lever is set to "Alarm", opening **S27**, and **S28** is switched on manually, connecting the mains to the clock-controlled switches **S24, S25**. The clock motor is permanently connected directly to the mains input. At a predetermined time the "On" switch **S25** closes, switching on the receiver.

When the receiver has warmed up, current flowing in the H.T. circuit energizes the relay winding **L17**, which operates and closes its associated contacts **S26**, short-circuiting **S25**. This action is necessary since **S25** contacts open approximately 30 minutes after they have closed and would otherwise switch the receiver off again.

When the desired time has elapsed the "Off" switch **S24** opens, switching the receiver off. Like **S25, S24** will in about half an hour revert to its former position, switching "On" again, but as **S25** is now open, and the relay is not energized, the receiver will remain switched off.

VALVE ANALYSIS

Valve voltages and currents given in the table below are those quoted by the manufacturers, who give the total H.T. current as 48 mA.

Valve	Anode Voltage (V)	Anode Current (mA)	Screen Voltage (V)	Screen Current (mA)
V1 ECH35	230 105 Oscillator	4.0 3.8	95	4.0
V2 EF39	216	5.2	70	1.7
V3 EBL21	217	25.0	230	3.0
V4 EZ35	250†	—	—	—

† Each anode, A.C.

COMPONENTS AND VALUES

RESISTORS		Values (ohms)	Locations
R1	V1 S.G. H.T. feed...	33,000	G5
R2	V1 hex. C.G. ...	680,000	J10
R3	V1 osc. C.G. ...	47,000	H6
R4	Osc. H.T. feed ...	33,000	H5
R5	V2 S.G. resistor ...	82,000	G5
R6	V2 H.T. decoupl. ...	2,200	F5
R7	I.F. stopper ...	47,000	F5
R8	A.V.C. decoupling ...	1,000,000	F7
R9	Sig. diode load ...	680,000	F5
R10	Volume control ...	1,000,000	E5
R11	V3 C.G. stopper ...	10,000	F7
R12	V3 G.B. and A.V.C. {	180	E7
R13	delay resistors ... {	220	E7
R14	V1, V2 fixed G.B. feed ...	6,800,000	F6
R15	A.V.C. diode load ...	1,000,000	F6
R16	V1, V2 fixed G.B. ...	220	F6
R17	Feed-back potential {	47,000	E6
R18	divider ... {	10,000	E6

CAPACITORS		Values (μF)	Locations
C1	Aerial L.W. shunt	0.00082	J11
C2	I.F. rejector tuning	0.0001	I9
C3	V1 hex. C.G. ...	0.0001	J9
C4	V1 S.G. decoupl. ...	0.1	G5
C5	1st I.F. transformer {	0.0001	A1
C6	tuning ... {	0.0001	A1
C7	Osc. anode coup. ... {	0.0001	H6
C8	V1 osc. C.G. ...	0.000047	H6
C9	Osc. fixed trim. ...	0.000033	I10
C10	H.T. R.F. by-pass ...	0.1	G6
C11	A.V.C. decoupling ...	0.05	J11
C12	Osc. reaction capa- f	0.00047	I11
C13	citers ... {	0.00082	I11
C14	Alarm C.G. coup. ...	0.1	H2
C15	Alarm osc. reaction f	0.1	G5
C16	capacitors ... {	0.1	G7
C17	V2 H.T. decoupl. ...	0.1	F6
C18	2nd I.F. transformer f	0.0001	C2
C19	tuning ... {	0.0001	C2
C20	I.F. by-passes ... {	0.0001	F5
C21	... {	0.0001	F3
C22	Alarm A.F. coup. ...	0.001	F5
C23*	V3 cath. by-pass ...	25.0	E7
C24	A.F. coupling ...	0.01	F5
C25	A.V.C. coupling ...	0.0001	F7
C26	Tone corrector ...	0.0025	F7
C27	Part F.-B. network	0.1	E6
C28*	H.T. smoothing {	24.0	C3
C29*	capacitors ... {	24.0	E6
C30†	—	—	—
C31†	—	—	—
C32†	Aerial M.W. tuning	—	—
C33†	capacitors ...	—	—
C34†	—	—	—
C35†	Aerial L.W. tuning	—	—

* Electrolytic, † Pre-set.

OTHER COMPONENTS

	Approx. Values (ohms)	Location	
L1	Aerial L.W. coup. ...	28.5	J10
L2	Frame aerial ...	2.05	B4
L3	Aerial L.W. tuning	19.5	J10
L4	I.F. rejector ...	11.0	J9
L5	—	0.8	I10
L6	—	1.0	I10
L7	Oscillator M.W. tuning coils ...	1.0	I11
L8	—	2.3	I11
L9	—	2.5	I12
L10	Osc. L.W. tune ...	9.0	I12
L11	1st I.F. trans. { Pri.	15.0	A1
L12	{ Sec.	15.0	A1
L13	2nd I.F. trans. { Pri.	15.0	C2
L14	{ Sec.	15.0	C2
L15	Speech coil ...	2.3	—
L16	Alarm osc. coil ...	135.0	F7
L17	Relay coil ...	310.0	C3
L18	Clock motor winding ...	11,500.0	B1
T1	Output { Pri.	500.0	E8
	{ Spk. sec.	0.5	E8
	{ F.-B. sec.	60.0	E8
T2	Mains { Pri., total	53.0	D2
	{ Heat. sec.	0.2	D2
	{ H.T. sec.	970.0	D2
S1-S22	Station selector switches ...	—	J12
S23	Tone alarm switch ...	—	G8
S24	Clock controlled {	—	B1
S25	switches ... {	—	C1
S26	Relay switch ...	—	B3
S27	Radio/Alarm switch ...	—	F5
S28	Mains sw. g'd R10	—	E6

DISMANTLING THE SET

Removing Chassis.—From the underside of the cabinet remove the four 4BA round-head screws at the sides of the speaker grille, and slide out the chassis and speaker as a complete assembly.

When replacing, do not omit to replace the light-excluding shield, which is secured by two spring clips above the scale lamps.

Removing Speaker.—Remove the four 6BA countersunk-head screws securing the sub-baffle to the chassis underside, and lift out the speaker to the extent of its leads.

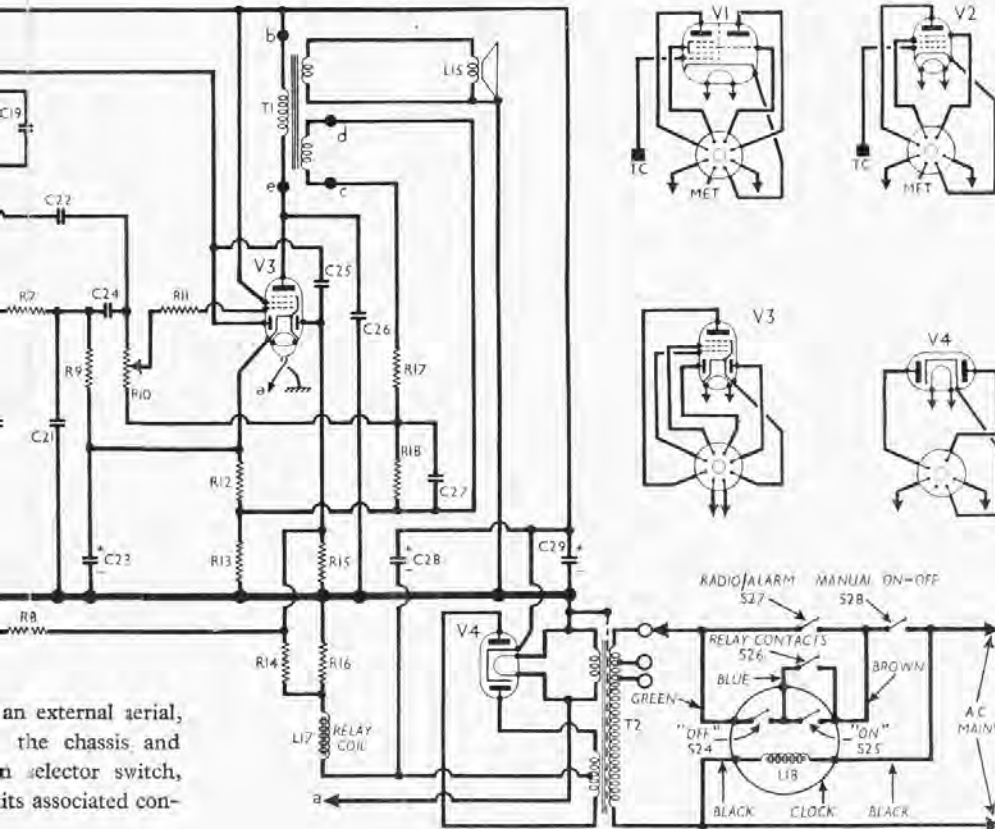

an external aerial, the chassis and selector switch, its associated con-

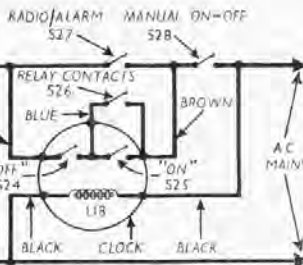

The speaker is secured to the sub-baffle by four nuts and bolts, and the connecting tags should point toward the top right-hand notched corner, when viewed from the rear. An earthing tag is fitted beneath the top fixing nut and joined to the adjacent speech coil tag and the yellow speaker lead.

When replacing, the notched corners of the sub-baffle should point toward the front chassis member.

Removing Back Cover and Frame Aerial Assembly.—Unscrew the two clock-setting control knobs (turn clockwise), remove the 6BA round-head screw on the relay mounting bracket, which secures the metal back cover support, and extract the two 2BA round-head back fixing screws.

When replacing, if the frame aerial leads have been disconnected, they should be re-soldered as indicated in our plan view of the chassis, where the connecting strip is shown. To prevent sticking of the clock-setting knobs, the threads of the spindles should be smeared with grease, and the knobs only fitted finger tight (turn anti-clockwise).

Removing Tuning Assembly.—Turn station selector switch to position 1 (pointer at 2 o'clock); unsolder V1 top cap connector, screw in the two bottom coil core screws, which project through holes in the rear edge of the chassis, and unsolder four leads from each tag strip connecting the assembly to the chassis.

Remove the six 6BA screws (with nuts) securing the side and rear flanges to the chassis deck, and the two 4BA screws (with nuts) holding the relay mounting bracket on the side of the assembly, taking care not to damage the relay, and lift out the unit from above the chassis.

The cover plate may be lifted off by detaching the switch spindle coupler (one cheese-head screw) and slackening the four cheese-head screws (with nuts) at the corners of the assembly.

When replacing, the switch spindle coupler should be fitted with its metal collar toward the cover plate, and the switch should be turned to position 1 to engage with the station selector coupler on the chassis.

The eight leads should be reconnected to the numbered points indicated in our under-chassis picture as follows: 1, yellow; 2, brown from L2; 3, red; 4, green; 5, black; 6, blue/red; 7, red/white; 8, brown.

Removing Front Plate Assembly.—To gain access to the volume control and clock for repair and replacement purposes, this panel must be removed.

Remove the control and clock setting knobs;

unclip the scale lamp holders and the transparent plastic front panel;

unsolder the five clock leads from their connecting strip, leaving the associated cable-form in place, and unsolder the nine leads to the volume control (which should be coded to assist replacement);

turn the station selector switch to position 3 (6 o'clock), remove the countersunk head grub-screw of the coupler, rotate the spindle to expose the grub screws in the associated gear wheel, which must be slackened, and withdraw spindle and gear wheel from chassis;

remove the two 6BA round-head screws securing the clock connecting strip, the cheese-head 4BA screw and mounting clamp of C29, and the two 4BA screws (with nuts), at each end of the chassis, which retain the front plate mounting brackets in position.

When replacing, the station selector pointer should be adjusted to position 3 (6 o'clock) after the gear wheel grub screws have been tightened. The positions of the five coloured clock connecting leads are indicated in our plan view of the chassis.

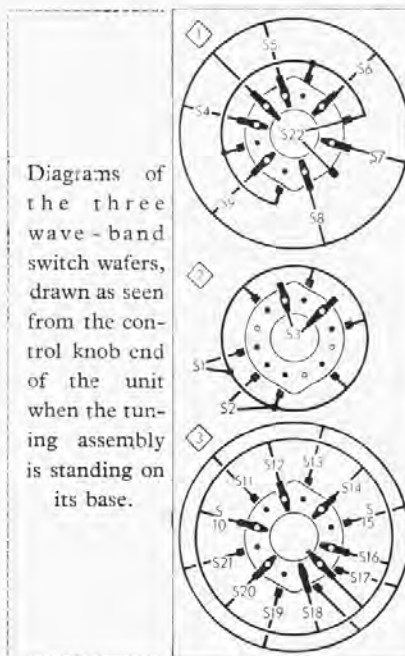

Diagrams of the three wave-band switch wafers, drawn as seen from the control knob end of the unit when the tuning assembly is standing on its base.

CO-ORDINATION OF CLOCK HANDS AND DIAL

Hands.—Unclip the transparent front panel, set hands to 12 o'clock, and adjust them for coincidence.

A.M./P.M. Dial.—Remove the single 6BA round-head screw (with nut) securing each end of the light diffusing strip to the front panel assembly, and bend the strip backward on the clock connecting leads to expose a rectangular slot in the top of the clock case, through which the edge of the A.M./P.M. dial is visible.

With a small screwdriver engage the edge of the dial and ease it round until "Noon" appears centrally in the fascia aperture.

"On" Dial.—Turn the "on" setting knob very slowly until the click of the internal cam is heard, and then adjust the associated dial, as previously described, through a slot in the side of the clock case until "12 noon" registers in the appropriate fascia aperture.

"Off" Dial.—Use the procedure described above.

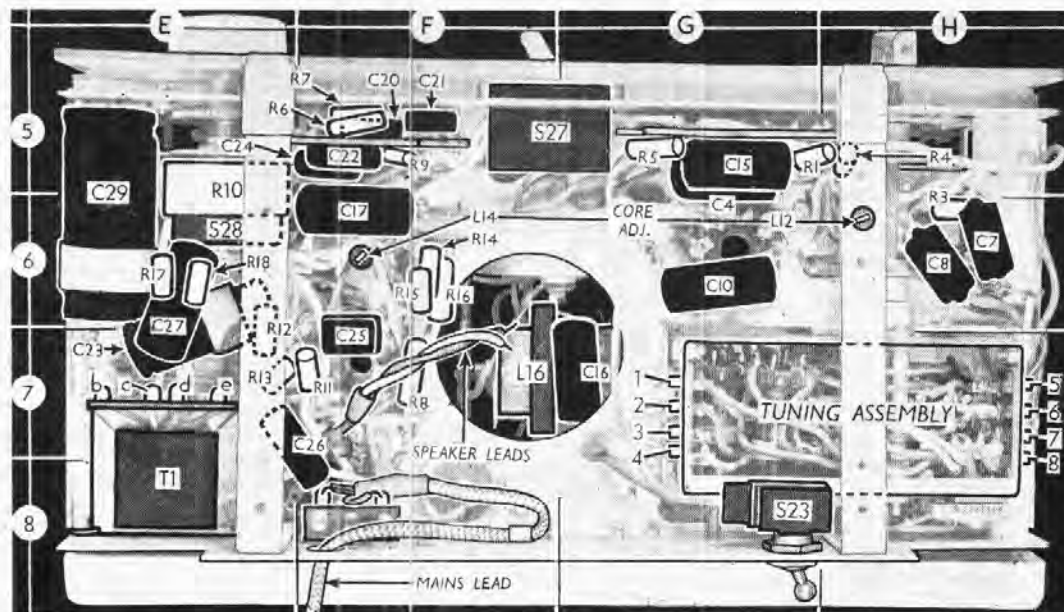

Under-chassis view. The outline of the tuning assembly is visible, and the eight connecting points to it, as shown in the circuit diagram, are indicated. The I.F. transformer secondary core adjustments are seen, and the connections to the output transformer T1 are lettered to conform with the circuit diagram.

Plan view of the chassis. The five connecting tags to the clock are shown, together with the associated lead colours. The relay mounting bracket has been broken away to reveal the relay contacts S26, and the capacitor C14 beneath it. The top of the tuning assembly is seen, and an interior view of it appears at the bottom of this column.

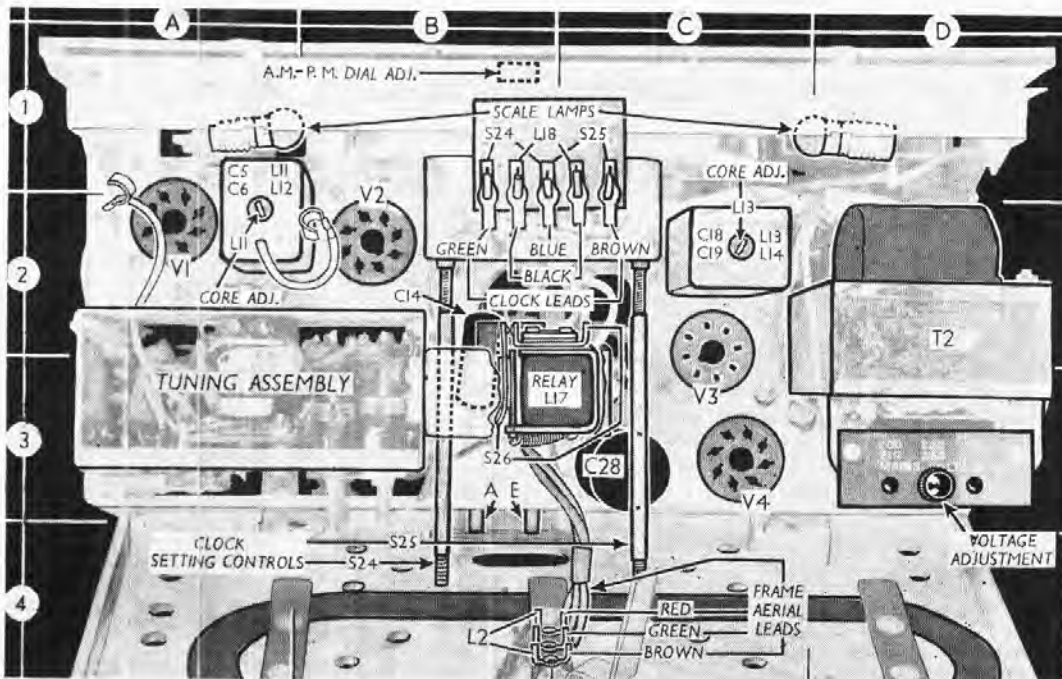

GENERAL NOTES

Tuning Assembly.—The aerial coils (excepting the frame winding L2), the six pre-set oscillator coils, the six-position three-gang switch unit and several small components are contained in a rectangular screening box mounted by flanges on the chassis deck.

Full instructions for removal and replacement are given under "Dismantling the Set."

Switches.—S1-S22 are the station selector switches, ganged in three rotary units which may be rotated continuously through 360 degrees. The units are indicated in our photograph of the tuning assembly, and shown in detail in the diagrams in column 3.

In both cases they are viewed from the front after removing the unit and standing it on its base. We found it necessary to dismantle the switch assembly to obtain access to the individual wafers.

The table (col. 5) gives the switch positions for the six control settings, starting from position 1 and turning the control clockwise. A dash indicates open, and C closed. S22 closes only between settings to suppress switching noise.

S23 is the Q.M.B. Tone Alarm control switch mounted at the rear of the chassis. The alarm tone is "On" when the switch knob is pushed to the right, viewed from the rear.

S24 and S25 are respectively the "Off" and "On" clock-controlled switches, located inside the clock housing. The connecting tags to these and the rest of the clock unit are indicated in our plan view, where the lead colours are shown to agree with similar markings in the circuit diagram.

S26 is the relay-operated switch, controlled by H.T. current flowing through L17. It closes shortly after the set is switched on, short-circuiting S25.

S27 is the "Radio-Alarm" change-over switch, in a Q.M.B. unit on the front chassis member. When its lever is set to the left, marked "Radio," S27 closes to short-circuit all the clock switching system, and the receiver is controlled manually by S28. When the lever is at "Alarm" (right), S27 opens, and provided that S28 has been closed, the clock then controls the receiver.

S28 is the Q.M.B. mains switch, ganged with the volume control R10.

Clock Unit.—All the adjustments associated with setting the clock correctly are given under "Dismantling the Set." The motor winding is connected permanently to the mains input circuit.

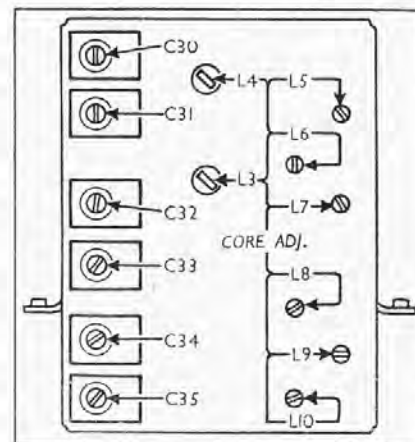

Rear view of the tuning assembly, showing all the R.F. and Oscillator adjustments.

CIRCUIT ALIGNMENT

I.F. Stages.—Turn station selector switch to position 1 (2 o'clock) and volume control to maximum; connect signal generator, via an 0.1 μ F capacitor in the "live" lead, to control grid (top cap) of V1 and the E socket. Feed in a 465 kc/s (645.16 m) signal, and adjust the cores of L13, L14, L11, L12 (location references C2, F6, A2, H6) in that order, for maximum output.

I.F. Rejector.—Transfer "live" signal generator lead to A socket, feed in a strong 465 kc/s signal, and adjust the core of L4 (J9) for minimum output.

STATION SETTING

Numbering the station selector switch positions clockwise, commencing with the pointer at 2 o'clock, the range of each is as follows: 1, 200-300 m; 2, 250-350 m; 3, 250-350 m; 4, 320-460 m; 5, 400-550 m; 6, 1,100-1,850 m. To set any channel, switch to the appropriate position and from the rear of the receiver adjust the associated oscillator core (right hand) and aerial trimmer (left-hand), preferably using the desired transmission as a signal.

A selection of alternative station names may be obtained by rotating the click-position indicator dials from the rear of the front panel.

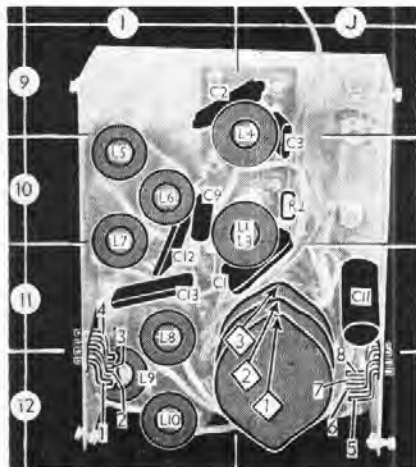

Front view of the tuning assembly, as seen when it is standing on its base.

Switch Table

Switch	1	2	3	4	5	6
S1						
S2						
S3	C	C	C	C	C	C
S4	C	C	C	C	C	C
S5		C				
S6			C			
S7				C		
S8					C	
S9						C
S10						C
S11	C	C	C	C	C	C
S12		C				
S13		C				
S14			C			
S15				C		
S16					C	
S17						C
S18					C	
S19					C	
S20						C
S21						C
S22*						C

* Closes between all settings.