

EVER READY PERSONAL-TYPE B



Four-valve medium waveband personal receiver in moulded plastic case. Sold by Ever Ready Co. (G.B.) Ltd., Hercules Place, Holloway, London, N7.

CAPACITORS

C	Capacity	Type
1	100pF	Tubular Ceramic
2	100pF	Tubular Ceramic
3	15pF	Silver Mica
4	430pF	Silver Mica
5	.1	Tubular 150V
6	.01	Tubular 350V
7	2	Electrolytic 150V
8	.1	Tubular 150V
9	100pF	Tubular Ceramic
10	.005	Tubular 350V
11	.1	Tubular 150V
12	100pF	Tubular Ceramic
13	20	Electrolytic 12V
14	.1	Tubular 150V
15	.005	Tubular 350V
16	100pF	Silver Mica
17	100pF	Silver Mica
18	100pF	Silver Mica
19	100pF	Silver Mica

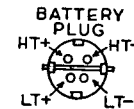
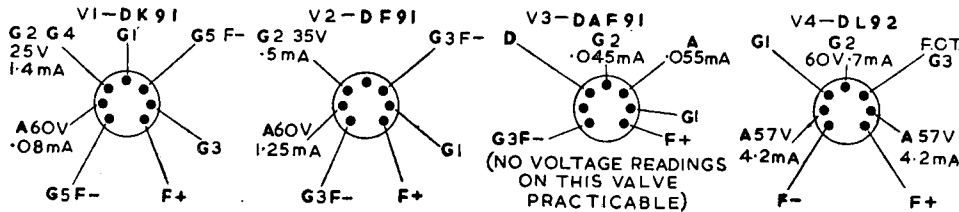
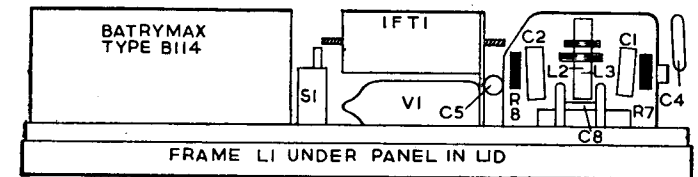
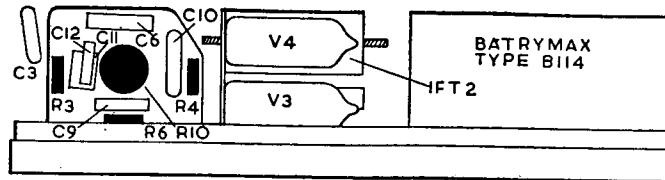
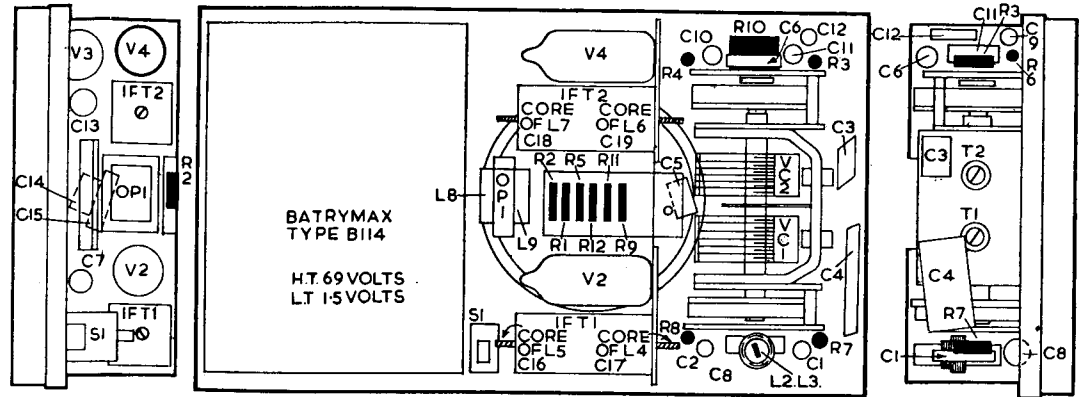

RESISTORS

R	Ohms	Watts
1	22k	1/2W
2	22k	1/2W
3	470k	1/2W
4	1m	1/2W
5	2.2m	1/2W
6	22k	1/2W
7	1m	1/2W
8	100k	1/2W
9	2.2m	1/2W
10	1m	Potentiometer
11	6.8m	1/2W
12	1k	1/2W

INDUCTORS

L	Ohms
1	1.3
2	2.25
3	.75
4	10
5	8
6	10
7	12
8	500
9	1.4
10	8.5

CIRCUIT consists of an heptode frequency-changer V1 coupled by a permeability-tuned transformer to an RF pentode V2, the IF amplifier. A second permeability-tuned transformer couples V2 to the diode rectifier section of V3. After rectification the signal is amplified by the pentode section of V3 before being fed to output pentode V4. The output from V4 is fed into a 3-in. PM loudspeaker. HT and LT are obtained from an all-dry battery, type B114.

Aerial. L1 consists of a frame or loop of approximately 20 turns of litz wire mounted underneath the Bakelised panel on the inside of lid of case. L1 is tuned by VC1 and trimmed by T1 and coupled to g3 of V1 by C1. AVC is fed to g3 through R7. C8 is decoupling capacitor. Suppressor g5 is internally connected to one side of filament. L4, C16, which form the primary of IFT1, are in the anode circuit of V1.

Oscillator is connected in a tuned-grid series-fed HT circuit. L2, the grid coil, is tuned by VC2 and trimmed by T2, C3. C4 is the padding capacitor. C2 couples the tuned coil to g1 of V1 and with grid leak R8 provides negative bias for the oscillator grid. The oscillator anode reaction voltages are developed by L3 and are applied to g2, g4 of V1. R1 is oscillator anode voltage dropping resistor.

IF amplifier operates at 465 kc/s. L5, C17,

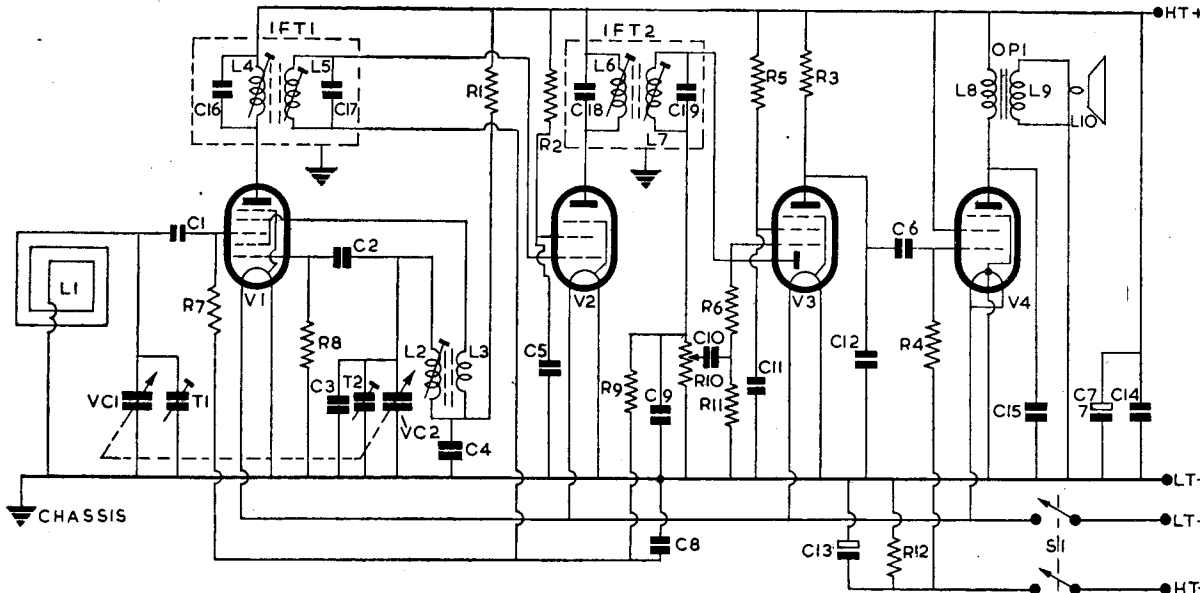

EVER READY PERSONAL-
TYPE B—Continued

the secondary of IFT1, feeds signal to g1 of V2, the IF amplifier valve. AVC is applied to g1 from R9 and is decoupled by C8. Screen g2 voltage is obtained from R2 and decoupled by C5. Suppressor g3 is internally connected to one side of filament. L6, C18, the primary of IFT2, is in the anode circuit of V2.

Signal rectifier. L7, C19, the secondary of IFT2, feeds signal to the diode anode of V3. R10, the volume control, is the diode load and C9 filter capacitor.

Automatic volume control is obtained from the DC component of the audio signal developed on R10 and is fed by R9 to g1 of V2 and g3 of V1. C8 is AVC line decoupling capacitor.

AF amplifier. The pentode section of V3 is used for this purpose. C10 feeds rectified signal to g1 of V3 through grid stopper R6. Negative bias for g1 is developed on C10 with R11 as grid leak. Screen g2 voltage is obtained from R5 and decoupled by C11. Suppressor g3 is internally connected to filament. R3 is the anode load resistor and C12 anode RF bypass capacitor.

Output stage. C6 feeds signal at anode of V3 to g1 of V4, the pentode output valve. Negative bias for g1 is obtained by connecting earthy end of grid resistor R4 to resistor R12 in the HT negative return to chassis. C13 decouples the bias voltage.

Screen g2 voltage is obtained direct from HT line. Suppressor g3 is internally connected to centre tap of the 3-volt filament. The two halves of the filament are externally connected in parallel in order to operate from the 1.5 volt LT supply. L8, the primary of OP1, the output matching transformer, is in the anode circuit of V4. C15 provides a fixed degree of tone correction. L9, the secondary of OP1, feeds into a three-inch PM loudspeaker L10.

High tension of 69 volts is provided by an Ever Ready Batrymax type B114 battery. The total current consumption of the receiver is 8 mA. One section of switch S1 breaks the HT negative line from battery to receiver. C7, C14 provide decoupling of the HT supply.

Low tension of 1.5 volts is obtained also from the above battery, the total filament current being 250 mA. The other section of switch S1 breaks the positive LT lead between battery and receiver. S1 is operated by the opening and closing of the lid of the receiver case. When the lid is open the receiver is switched on.

Removal of chassis. Place receiver with lid face downwards on bench and release catch at one end of the case. Lift case (catch end first) and disengage it from claws at other end. Lift battery out of clips and remove battery plug.

Remove screen in centre of black insulating cover screen over receiver chassis and remove cover.

Most of servicing can be carried out without further dismantling. If the chassis is required to be removed from the top panel then the wires to frame aerial connecting strips should be unsoldered.

Next carefully unscrew bolts adjacent to volume and tuning dial apertures on top panel. These bolts have nuts securing them on the underside. Also remove bolts holding ON/OFF switch in position. Chassis can now be separated from the top panel.

Frame aerial can be inspected by removing the five press studs holding Bakelised cover plate on inside of lid.

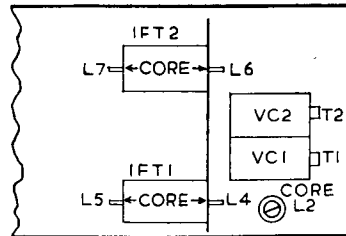

TRIMMING INSTRUCTIONS

Apply signal as stated below	Tune receiver to	Trim in order stated for max. output
1) 465 kc/s to G1 of V2 via .1 capacitor	Gang cond. at min.	Cores of L7, L6
2) 465 kc/s to G3 of V1 via .1 capacitor	Ditto	Cores of L5, L4
3) 1.2 mc/s via a loop not less than 2ft. from frame Ae	250 metres	T2
4) 600 kc/s as above ..	500 metres	Core L2 and repeat (3)
5) 1.2 mc/s as above ..	250 metres	T1

Note.—The IF transformers have been carefully adjusted by the manufacturers on special visual alignment apparatus and unless there are definite reasons to believe that these transformers are off tune it is advisable not to interfere with them.

USEFUL BOOKS
FOR
SERVICE STUDENTS

Radio Questions and Answers. Vol. II: Radio Receivers.—By E. M. Squire. Sir Isaac Pitman & Sons, Ltd., Parker Street, Kingsway, London, WC2. 152 pages. 10s. 6d. For students preparing for examinations in radio receivers and servicing. It assumes a knowledge of basic radio as given in an earlier book by the same author, *Basic Radio*.

A Practical Course in Magnetism, Electricity and Radio.—By W. T. Perkins AMBritIRE, AMInstBE., and A. Charlesby, PhD, BSc, ARCS, DIC. Third edition. George Newnes, Ltd., Tower House, Southampton Street, Strand, WC2. 312 pages. 10s. 6d. This book was first published in 1942. It deals with a variety of practical experiments which demonstrate the behaviour and effects of magnetism and electricity in their different applications and circuits, confirming also the formulae built up. It is, of course, the method adopted by technical colleges and the Services, and the only real way to learn anything thoroughly.

C. JONES
RADIO & ELECTRICAL ENGINEERS

"I can save you a lot of trouble!"

by curing H.F. Resistance WITHOUT DISMANTLING. For a lasting job all you have to do is to put a few drops of SERVISOL on all electrical contacts in your set—there are dozens of them. Resistance drops instantly, crackles disappear and volume increases. There is no substitute for Servisol.

At all Wholesalers.
5/- 1-pint tin with a spout.
Nett Trade.

Head Office
14 North John Street
LIVERPOOL 2

Servisol Ltd.

Count SEVEN
and
SOLDER!

All you do is switch on, press the trigger and the bit is hot in 7 seconds. Nothing could be speedier or safer. Heating bit cools instantly trigger is released, and when Gun is placed down, bit is held away from contact with carpets, table or bench. A boon to manufacturers, to radio servicemen and the handyman. Bits are easily changed and Gun can be used on A.C. 200-250 v. or 100-130 v.

Obtainable through Wholesalers or write direct to:
BURGOYNE ENG. CO. LTD., LONDON, N.W.1

79/6 with 2 spare bits and 4 yds. of flex

SECOND Induction SOLDERING GUN

A. E. POWELL LTD.,
118, SHEEN ROAD,
RICHMOND, SURREY
Telephones: RIC. 5044, RIC. 0512.

Announce
the issue of a new
"SUMMER SEASON"
Catalogue complete with
"NEW LOOK" prices.

Be "IN THE FASHION"
and obtain yours now.

"GOOD SERVICE
with
SERVICE GOODS"