

# GRUNDIG "MARLBOROUGH" Model 3028/W/3D

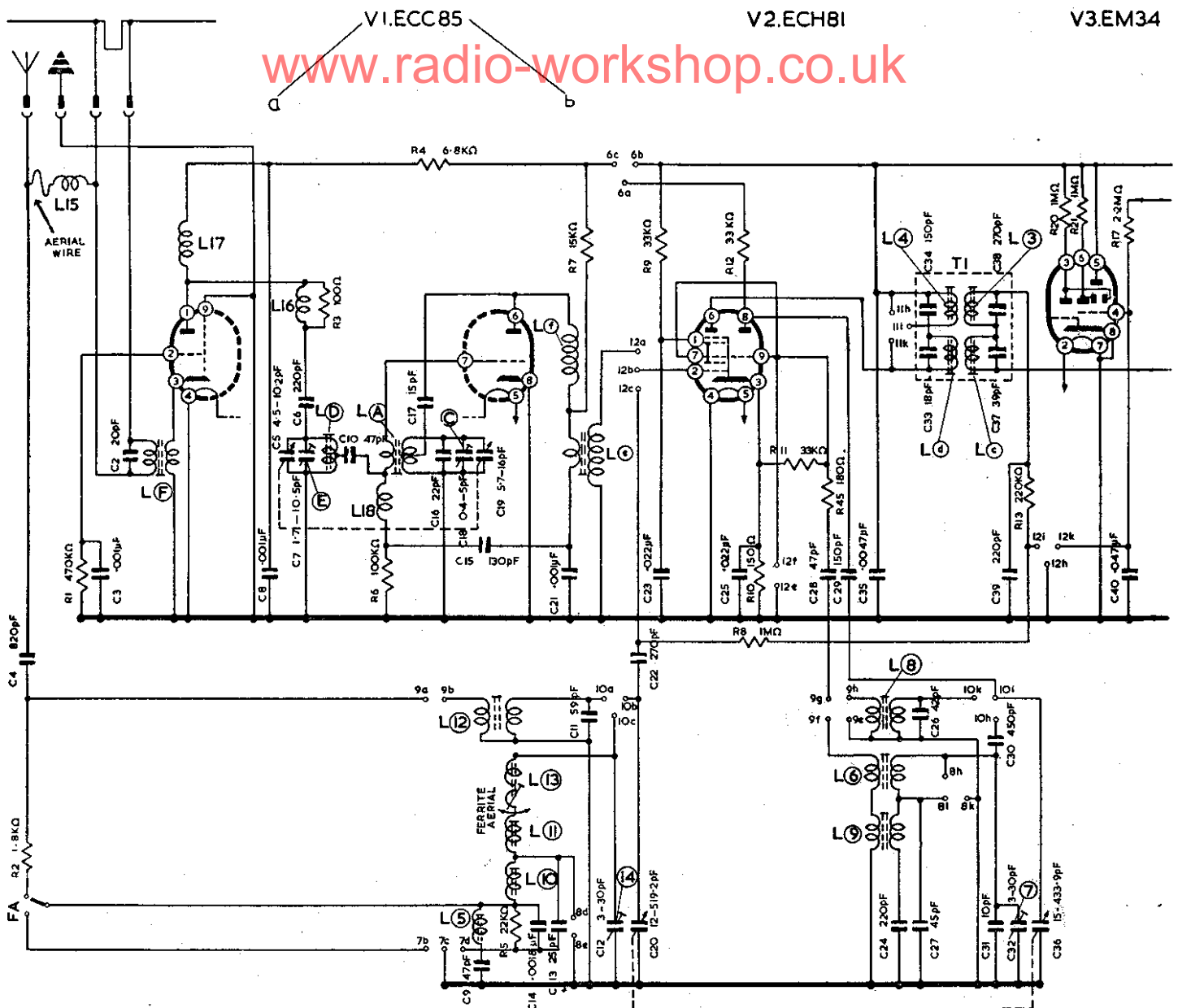

CIRCUIT DIAGRAM—GRUNDIG "MARLBOROUGH" MODEL 3028/W/3D

**General Description:** Six-valve (including tuning indicator), four-waveband (L.W./M.W./S.W./V.H.F.), combined A.M./F.M. table receiver with four independent tone controls and three dynamic loudspeakers. Rotatable ferrite-rod aerial and provision for external aerials. Diode socket for use with tape recorder.

**Power Supplies:** A.C. mains, 110 and 190–250 volts.

**Valves:** (V<sub>1</sub>) ECC85; (V<sub>2</sub>) ECH81; (V<sub>3</sub>) EM34; (V<sub>4</sub>) EF89; (V<sub>5</sub>) EABC80; (V<sub>6</sub>) EL84.

**Servicing Notes:** R<sub>15</sub> provides overload protection for the I.F. transformers and should not be replaced with a resistor rated above  $\frac{1}{3}$  watt. A check point is provided for the V.H.F. oscillator; this is a small piece of wire behind C<sub>5</sub>, C<sub>19</sub> from which the negative grid bias can be measured with an Avo model 8 (20,000-ohms/volt) meter (should be approximately 2.5 volts).

V4.EF89

V5.EABC80

EL84

www.radio-workshop.co.uk

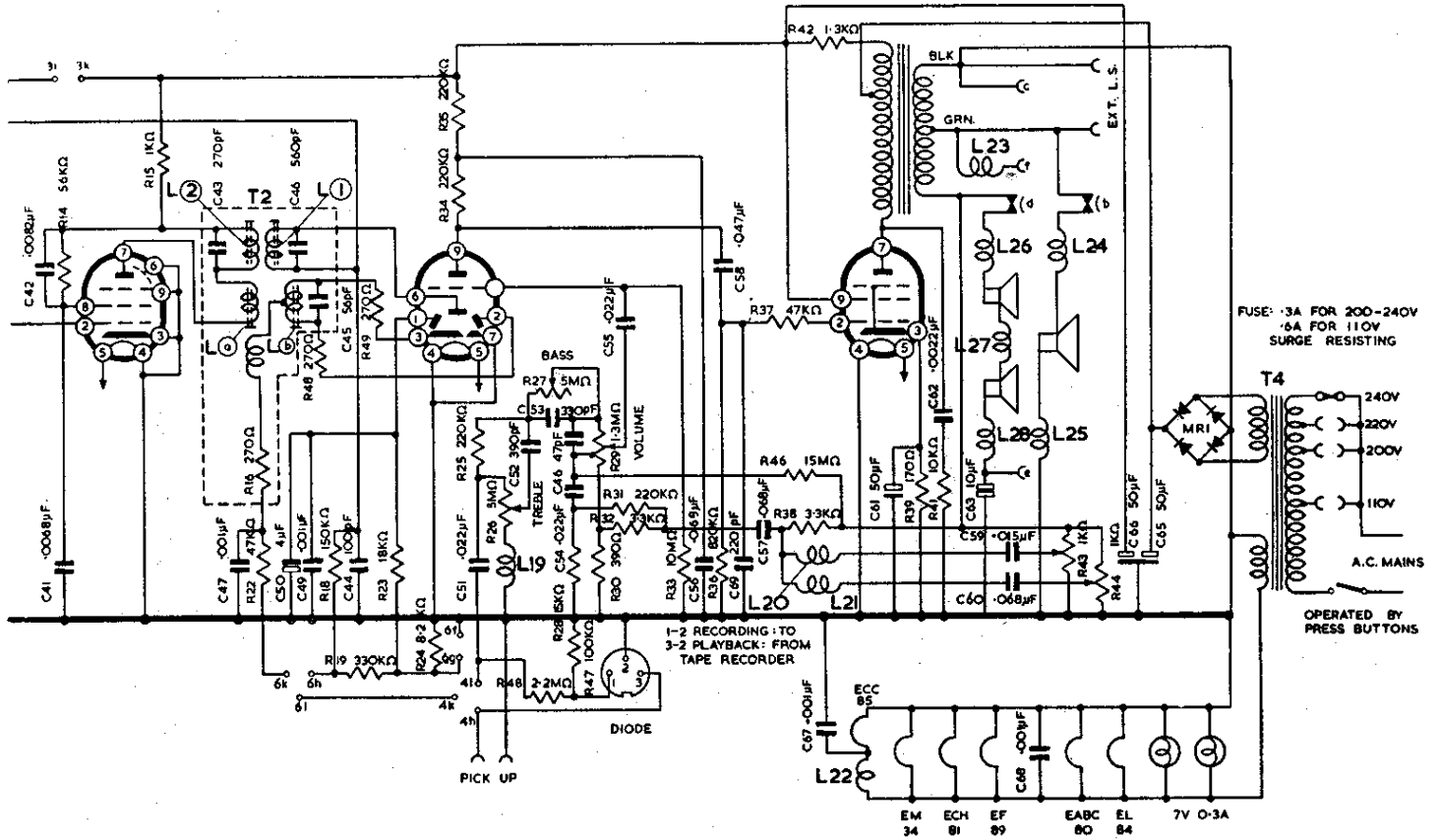

FUSE: .3A FOR 200-240V  
.5A FOR 110V  
SURGE RESISTING

OPERATED BY PRESS BUTTONS

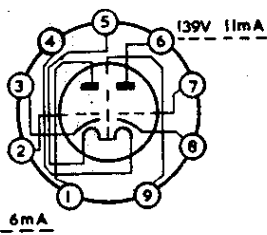

ECC85

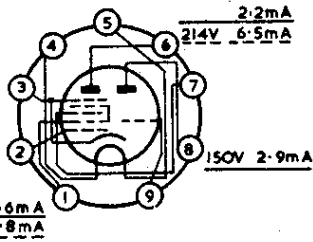

ECH81

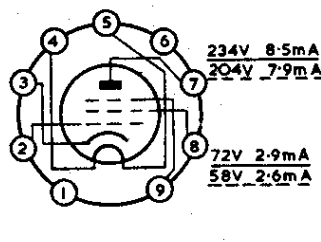

EF89

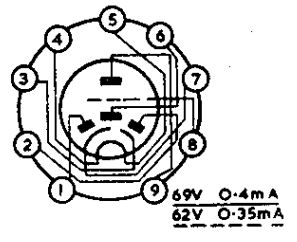

EABC80

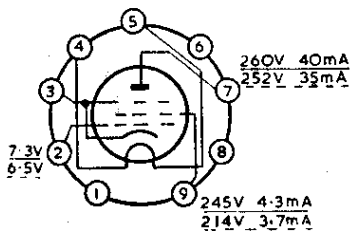

EL84

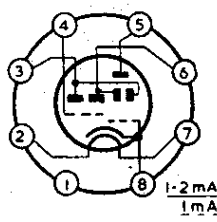

EM34

VALVE VOLTAGES AND BASE CONNECTIONS

— READINGS TAKEN IN MEDIUM WAVE POSITION  
- - - READINGS TAKEN IN VHF POSITION

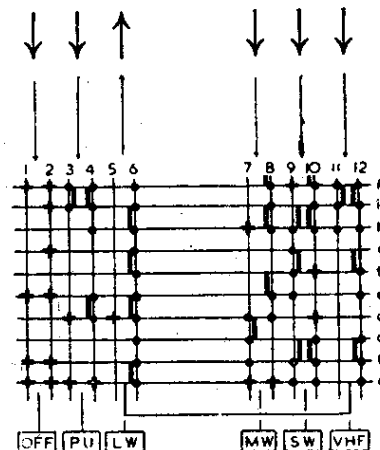

KEY TO SWITCH CODING

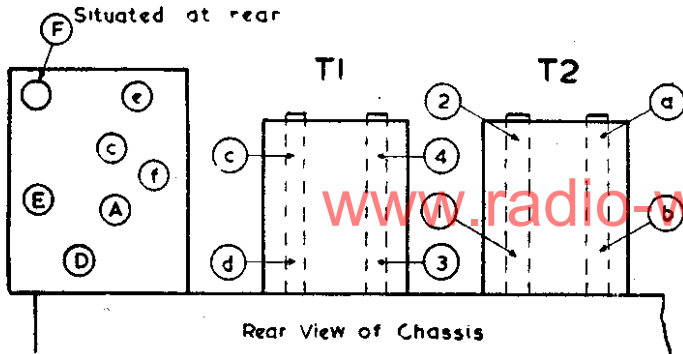

ALIGNMENT POINTS

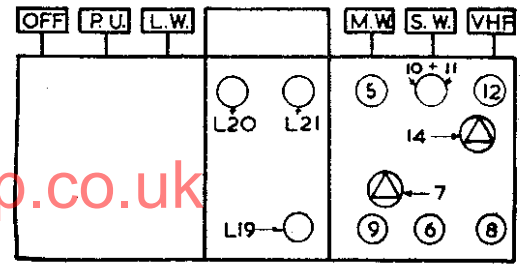

COILS VIEWED FROM UNDER CHASSIS

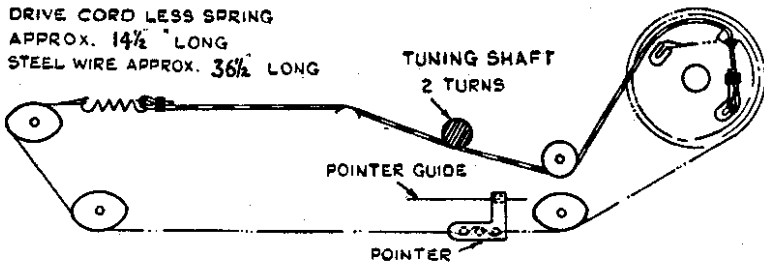

F.M. CORD DRIVE ASSEMBLY

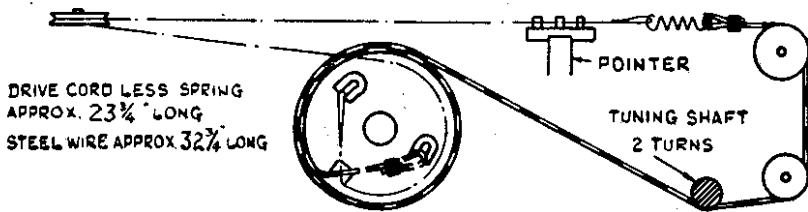

A.M. CORD DRIVE ASSEMBLY

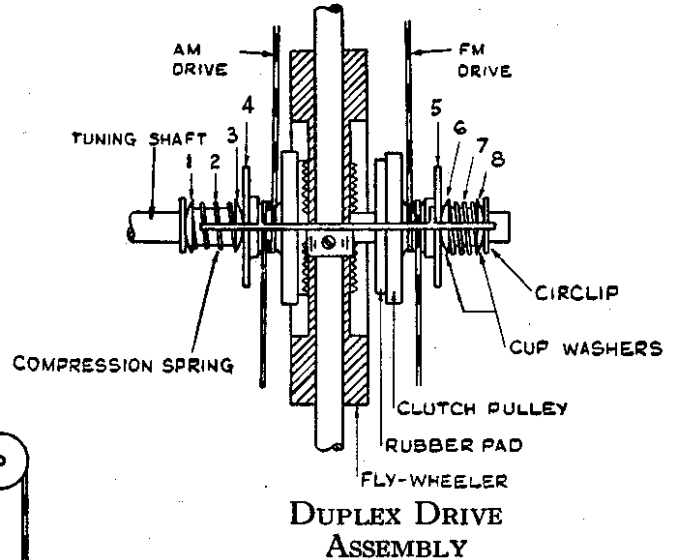

Always make sure that loudspeaker connections are returned as found, as incorrect wiring will give rise to audio instability. Switch cleaning fluids should be applied very sparingly—if at all—to avoid damage to coil formers and cores.

**Frequency Response Control:** The coils are factory set, and should normally not require readjustment. However, if necessary, the following procedure should be used: Feed into the pick-up terminals a signal of 1.8 kc/s. Turn the bass, upper middle and top frequency controls to minimum; then, with lower middle frequency control at maximum, adjust L20 for maximum output. Turn this control to minimum, and return upper middle control to maximum; inject a 2.6-kc/s. signal and adjust L21 for maximum output.

**Duplex Drive:** The special drive enables an F.M. station to be tuned without upsetting the setting of the A.M. drive, and vice versa. The assembly is shown in the accompanying diagram. The clutch pulleys are faced with rubber pads which are pressed against serrations on the flywheel when the actuating fork is operated by push buttons. The clutch pulleys, which also hold drive cords, slide easily due to their long bushes, which reach into their respective compression springs. The adjustment of the clutches can be achieved by movement of the actuating fork, the flywheel or the lever on the F.M. button. It is important to ensure that the latter does not scrape

against the edge of the chassis holding the press buttons and coil pack. The force of the clutching pulleys against the flywheel should be equal, and in the non-engaged position they should be about  $\frac{1}{8}$  in. away from the flywheel.

**Alignment Procedure:** The following notes relate mainly to the use of an A.M. signal generator and meter, although it should be emphasised that the most efficient method is to use a wobblator and oscilloscope. Before alignment, the mains voltage should be set correctly and the pointer brought into line with the right-hand side of the dial with the tuning gang at maximum. Always align S.W., M.W. and L.W. circuits before adjusting V.H.F. circuits.

The output of the signal generator should be reduced as necessary to provide an output across the extension loudspeaker terminals of not more than 0.865 volts (100 mW.). As an output meter a 10–20-volt f.s.d. D.C. meter connected across C50 may be used, a negative reading being obtained.

**I.F. (A.M.):** 468 kc/s. Damp the core not being adjusted with a 10k resistor in series with a 500-pF. capacitor. Tuning gang should be set at maximum capacitance, with set switched to S.W. for operations (a) and (b), and to M.W. for (c). (a) Inject a 468-kc/s. signal to signal grid of EF89 and align points (1) and (2). (b) Inject a 468-kc/s. signal to signal grid of ECH81 and adjust points (3) and (4). (c) Inject a 468-kc/s. signal to aerial and earth socket via dummy aerial (250 pF. in series with 100 ohms) and adjust point (5) for minimum.

**R.F. (A.M.):** Proceed as follows:

Generator Frequency	Pointer Reading	Generator to	Alignment Points	
			Osc.	R.F.
M.W. 550 kc/s.	545 m.	Aerial	(6) Max.	(11) Max.
1500 kc/s.	200 m.	Aerial	(7) Max.	(14) Max.
S.W. 6.5 Mc/s.	6.5 Mc/s.	Aerial	(8) Max.	(12) Max.
L.W. 175 kc/s.	1820 m.	Aerial	(9) Max.	(10) Max.

**I.F. (F.M.):** To adjust the ratio detector, a 10.7 Mc/s. A.M. signal is injected to the grid of the EF89 and coil L(a) is adjusted for maximum output. Coil L(b) is then adjusted for minimum output. If the generator can be frequency modulated this should be connected to the grid of the ECH81 and L(c) and L(d) adjusted for maximum. Then connect to the grid of the second section of the ECC85 and adjust L(e) and L(f). The alignment of the ratio detector is correct if maximum amplitude limiting takes place when an F.M. generator is tuned to exactly 10.7 Mc/s.

**R.F. (F.M.):**

Generator Frequency	Pointer Reading	Generator to	Alignment Point
91 Mc/s.	91 Mc/s.	Aerial Input	(A) and (C) max.
88.5 Mc/s.	88.5 Mc/s.		(D) max.
99.5 Mc/s.	99.5 Mc/s.		(E) max.