

"TRADER" SERVICE SHEET

959

H.M.V. 1117

and 1608 Autoradiogram



The appearance of the H.M.V. 1117 table superhet. Twin speakers are situated either side of the press-button file.

EIGHT press-buttons are used for waveband and pick-up switching and pre-set station selection in the H.M.V. 1117, a 4-valve (plus rectifier), 3-band superhet, designed to operate from A.C. mains of 195-255 V, 50-100 c/s. Two speakers are used, and there are bass and treble tone controls.

The H.M.V. 1608 is an autoradiogram employing a modified 1117 chassis, the difference being

described under "General Notes" overleaf. This Service Sheet was prepared from a 1117. Release date, both models, June, 1948. Original prices; 1117, £26 6s 6d; 1608, £32 6s 4d. Purchase tax extra.

CIRCUIT DESCRIPTION

All the switches associated with the press-button unit have been coded so as to indicate their action when a button is pressed. Thus a switch bearing the suffix a, b, c, d or e closes when its button is pressed, while one bearing an x, y or z opens. When the button is released these actions are reversed. Each button, with the exception of Gram., operates two sets of switches, one in the aerial circuit and one in the oscillator circuit. All the switches in both groups operated by a given button bear the same number, the individual switches being identified by their suffixes.

The aerial is coupled inductively on all ranges by L1, L2, L3 to single-tuned circuits comprising L4 (S.W.), L5 (M.W.) and L6 (L.W.) tuned manually by C45 or automatically by pre-set capacitors C44, C43, C42 (M.W.) or C41 (L.W.). Image suppression on L.W. by C2 connected across L3.

First valve (V1, Marconi X148) is a triode-heptode operating as a frequency changer with internal coupling. For manual tuning, triode oscillator grid coils L11 (S.W.), L12 (M.W.) and L13 (L.W.) are tuned by C46. Parallel trimming by C47 (M.W.) and C13, C48 (L.W.). Series tracking by C12 (S.W.), C11 (M.W.) and C14, C11 (L.W.). Reaction coupling from anode by L14 and the common impedance of tracker C12 (S.W.), L15 (M.W.), and the common impedance of C14 (L.W.).

For automatic tuning, coils L10, L9, L8 (M.W.) or L7 (L.W.) are tuned by C9 and C14 in a

Colpitts circuit, tuning adjustments being made by means of the pre-set coil cores.

Second valve (V2, Marconi W148) is a variable-mu R.F. pentode, operating as an intermediate frequency amplifier with tuned transformer couplings C5, L16, L17, C6 and C18, L18, L19, C19.

Intermediate frequency 465 kc/s.

The diode signal detector is part of double diode triode valve (V3, Marconi DH63). Audio frequency component in rectified output is developed across load resistors R11, R12, and on M.W. and L.W., when S1z is closed, that across R12 is passed via C25 and manual volume control R14 to grid of triode section. On S.W., S1e closes and S1z opens, passing the total audio signal from R11, R12 through C24, increasing the A.F. output and introducing bass attenuation. I.F. filtering by C20, R10, C21. Tone compensation in volume control circuit by R13, C26, providing bass boost at the low volume settings of the control.

Provision is made for the connection of a pick-up across R14 via S8b, which closes when the Gram. button is depressed. S8x opens and S8a closes on Gram. to prevent radio breakthrough.

Second diode of V3, fed via C23 from V2 anode, provides D.C. potentials which are developed across load resistors R18, R19. The total potential is fed back to F.C. valve, and a proportion of it, developed across R19, is fed back to I.F. valve, giving automatic gain control.

Resistance-capacitance coupling by R17, C29 and R25 between V3 triode and beam tetrode output valve (V4, Marconi KT61). Separate bass and treble variable tone control, by negative feedback between anode and grid of V4 via

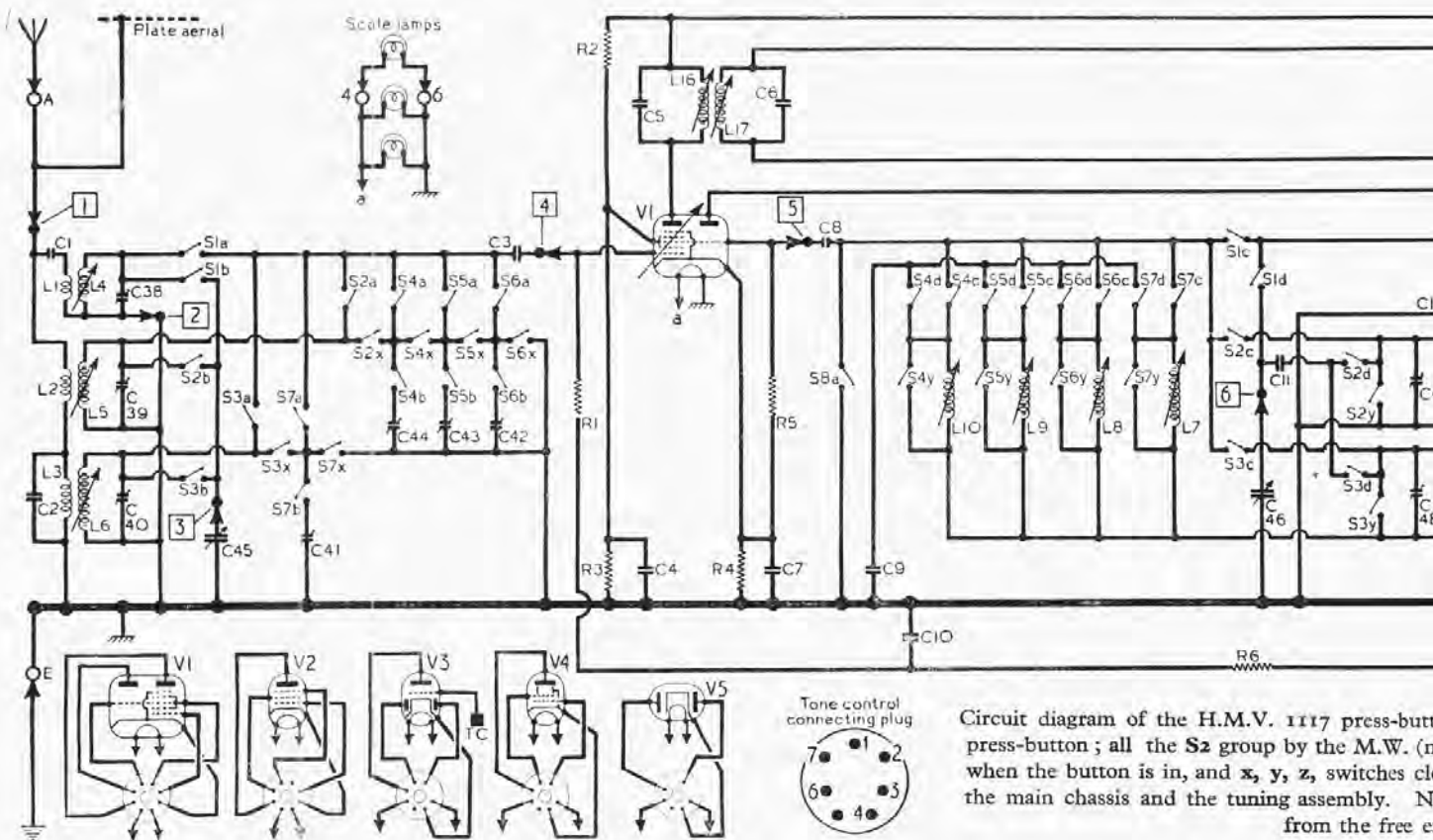

Circuit diagram of the H.M.V. 1117 press-button radio receiver; all the S2 group by the M.W. (n) when the button is in, and x, y, z, switches close to the main chassis and the tuning assembly. Note the connection from the free end of the...

COMPONENTS AND VALUES

RESISTORS		Values	Locations
R1	V1 hept. C.G. ...	470kΩ	F3
R2	V1 S.G. H.T. feed ...	22kΩ	G4
R3	pot. divider ...	22kΩ	G4
R4	V1 G.B. ...	220kΩ	F3
R5	V1 osc. C.G. ...	47kΩ	F3
R6	A.G.C. decoupling ...	1MΩ	F4
R7	Osc. H.T. feed ...	82kΩ	F4
R8	V2 S.G. H.T. feed ...	33kΩ	G3
R9	V2 G.B. ...	330kΩ	G4
R10	I.F. stopper ...	100kΩ	G5
R11	Signal diode load ...	220kΩ	G5
R12	resistors ...	680kΩ	G5
R13	Tone comp. ...	22kΩ	E3
R14	Volume control ...	2MΩ	D3
R15	V3 G.B. ...	2.2kΩ	G4
R16	V3 H.T. decoup. ...	47kΩ	F4
R17	Triode anode load ...	150kΩ	F4
R18	A.G.C. diode load ...	470kΩ	F4
R19	A.G.C. diode load ...	470kΩ	G4
R20	Neg. feedback ...	47kΩ	F4
R21	Bass control ...	500kΩ	—
R22	Neg. feedback ...	100kΩ	E4
R23	Treble control ...	100kΩ	—
R24	Neg. feedback ...	100kΩ	E4
R25	V4 C.G. ...	330kΩ	E5
R26	Grid stopper ...	47kΩ	E5
R27	V4 G.B. ...	100Ω	F5
R28	Spkr. Load ...	10Ω	E5

CAPACITORS		Values	Locations
C1	Aerial series ...	47pF	F3
C2	Image rejector ...	470pF	B1
C3	V1 hept. C.G. ...	100pF	F3
C4	V1 S.G. decoup. ...	0.047μF	G4
C5	1st I.F. transformer ...	200pF	A2
C6	tuning ...	200pF	A2
C7	V1 cath. by-pass ...	0.047μF	F3
C8	V1 osc. C.G. ...	68pF	E3
C9	Osc. P.-B. tune ...	270pF	H1
C10	A.G.C. decoup. ...	0.047μF	G3
C11	M.W. tracker ...	510pF	H1
C12	S.W. tracker ...	0.0039μF	E3
C13	L.W. trimmer ...	47pF	H1
C14	L.W. tracker ...	250pF	B1
C15	Osc. anode coupling ...	47pF	E3
C16	V2 S.G. decoup. ...	0.047μF	G3
C17	V2 cath. by-pass ...	0.047μF	G4
C18	2nd I.F. transformer ...	100pF	A2
C19	tuning ...	100pF	A2
C20	I.F. by-passes ...	100pF	G5
C21	I.F. by-passes ...	100pF	G5
C22	A.G.C. line decoup. ...	0.047μF	G4
C23	A.G.C. feed ...	100pF	G5
C24	Bass "cut" ...	220pF	B1
C25	A.F. coupling ...	0.047μF	B1
C26	Tone comp. ...	0.022μF	E3
C27	V3 cath. by-pass ...	50μF	F4
C28	V3 anode decoup. ...	2μF	F4
C29	A.F. coupling ...	0.047μF	F4
C30	Neg. feed-back ...	0.01μF	F4
C31	Top "cut" ...	0.01μF	E4
C32	V4 cath. by-pass ...	50μF	E4
C33	Tone corrector ...	0.0015μF	E4
C34	H.T. smoothing ...	16μF	A1
C35	S.W. aerial trim. ...	35pF	H8
C36	M.W. aerial trim. ...	45pF	H7
C37	L.W. aerial trim. ...	135pF	H7
C38	L.W. pre-set ...	450pF	H6
C39	Aerial M.W. pre-set ...	450pF	H6
C40	—	135pF	H7

CAPACITORS (continued)		Values	Locations
C43†	Aerial tuning ...	—	B2
C46†	Osc. tuning ...	—	B2
C47†	M.W. osc. trim. ...	45pF	J8
C48†	L.W. osc. trim. ...	135pF	J7

† Variable. ‡ Pre-set.

OTHER COMPONENTS		APPROX. values (ohms)	Locations
L1	Aerial coupling coils	0.1	H8
L2	Aerial coupling coils	27.8	H8
L3	Aerial coupling coils	64.0	H7
L4	S.W. aerial tune	0.1	H8
L5	M.W. aerial tune	3.0	H8
L6	L.W. aerial tune	19.0	H7
L7	Oscillator pre-set tuning coils	10.7	J6
L8	Oscillator pre-set tuning coils	5.0	J6
L9	Oscillator pre-set tuning coils	5.0	J6
L10	S.W. osc. tune	2.5	J7
L11	S.W. osc. tune	0.1	J8
L12	M.W. osc. tune	2.1	J7
L13	L.W. osc. tune	7.5	J7
L14	S.W. reaction	0.1	J8
L15	M.W. reaction	2.6	J7
L16	1st I.F. trans. {Pri.}	5.0	A2
L17	1st I.F. trans. {Sec.}	5.0	A2
L18	2nd I.F. trans. {Pri.}	5.0	A2
L19	2nd I.F. trans. {Sec.}	5.0	A2
L20	Speech coil	2.9	—
L21	Hum neut. coil	2.0	—
L22	Field coil	970.0	—
L23	Speech coil	2.9	—
T1	Output trans. {Pri.}	690.0	D4
	Output trans. {Sec.}	0.1	—
T2	Output trans. {Pri., total}	44.0	—
	Output trans. {H.T. sec. total}	600.0	—
	Output trans. {Rect. htr. sec.}	0.4	C2
	Output trans. {6.3 v. htr. sec.}	0.1	—
S1-S8	P.-B. switches	—	J7
S9, S10	Speaker switch	—	D5
S11	Mains sw. g'd	—	D3

R24, C31, C32 R22, R21, C30 and R20 (bass cut), and by C33, R23 in grid circuit of V4 (treble cut). Fixed tone correction by C35 in anode circuit.
Provision is made for the connection of a low-impedance external speaker, and speaker switch S9, S10 permits either the external or internal speakers, or both, to be used. Load resistor R28 is permanently connected across the external speaker sockets to protect the output valve.
H.T. current is supplied by I.H.C. full-wave rectifying valve (V5, Marconi U70). Smoothing by speaker field L22 and electrolytic capacitors C36 and C37.

(continued next column)
* Electrolytic; ‡ Pre-set.

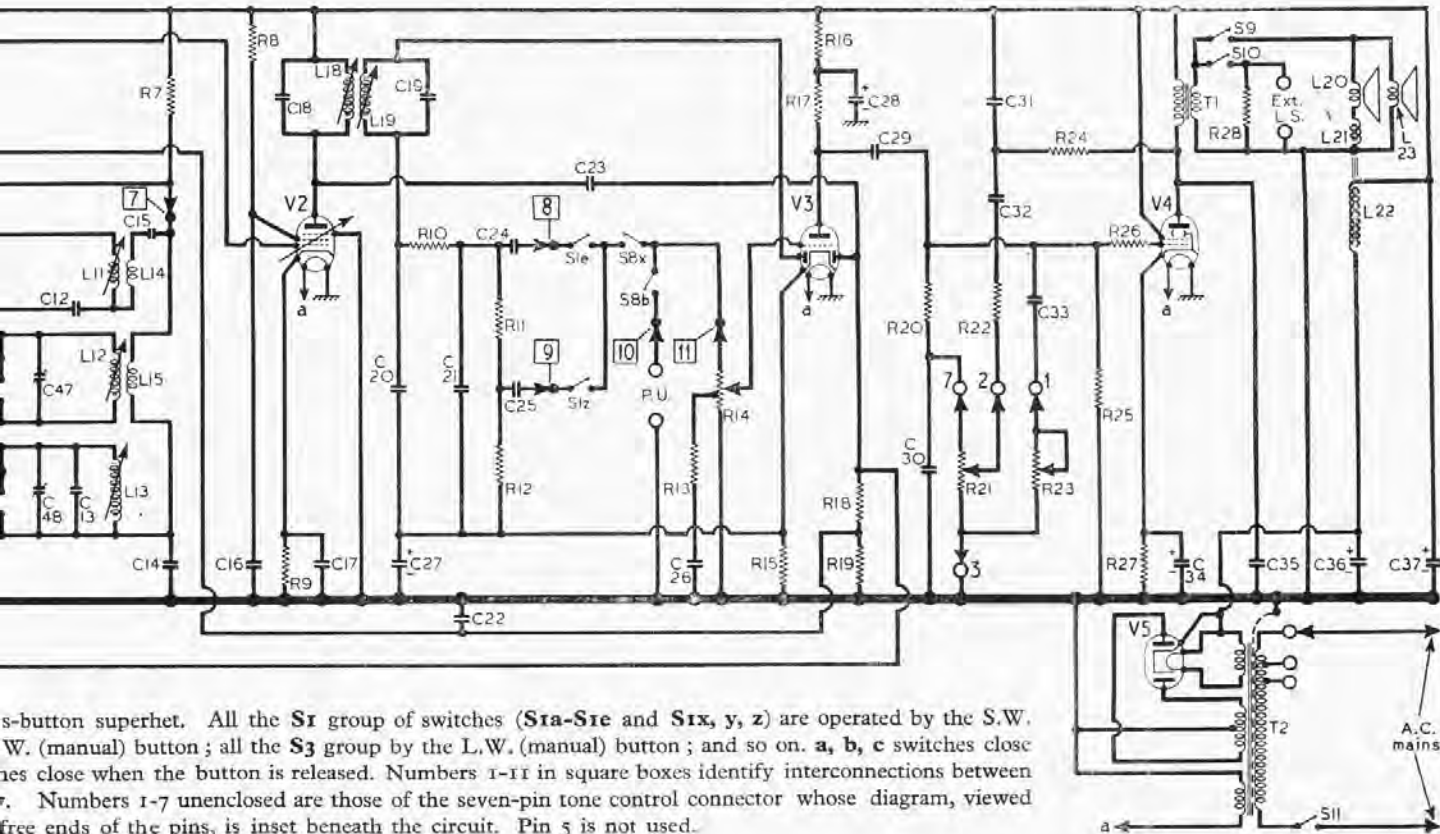

s-button superhet. All the S1 group of switches (S1a-S1e and S1x, y, z) are operated by the S.W. (manual) button; all the S3 group by the L.W. (manual) button; and so on. a, b, c switches close when the button is released. Numbers 1-11 in square boxes identify interconnections between components. Numbers 1-7 unenclosed are those of the seven-pin tone control connector whose diagram, viewed from the free ends of the pins, is inset beneath the circuit. Pin 5 is not used.

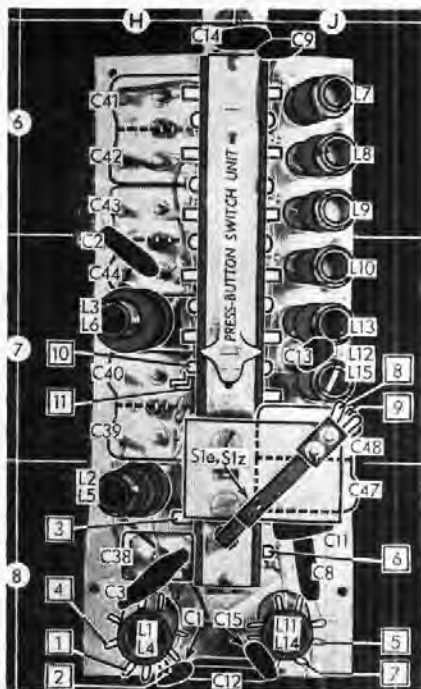

Right. Rear view of the tuning assembly after removal. The eleven connecting tags are indicated by numbered squares.

Left. Sketch of the front of the assembly, identifying the press-buttons and alignment adjustments.

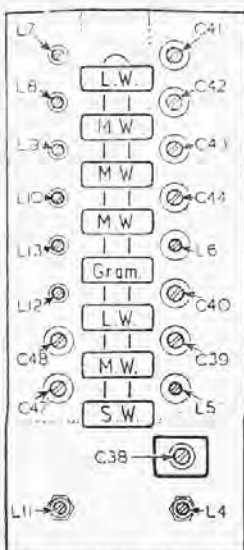

DISMANTLING THE SET

Removing Chassis.—Remove the two domed control knobs (recessed grub screws); withdraw 7-pin plug, on right hand side of press-button unit, from its socket on the chassis deck; release drive wire from cursor clamp; remove the nut (and lock nut), securing top of press-button unit to front of cabinet; remove scale lamps (pull off), unsolder the black scale lamp leads from the earthing tag at the right hand end of scale backing plate, and release leads from brass clips on either side of the cabinet; unsolder the yellow plate aerial lead from tag at the top left-hand corner of the rear of the cabinet; remove the four chassis fixing bolts (with claw-washers and lock-washers), slide chassis rearwards and unsolder the speaker leads, when the chassis can be withdrawn. **When replacing,** connect the red speaker lead to the upper tag on the left of the energized speaker, and the blue lead to the lower tag, connect the yellow and black speaker leads to the left and right-hand tags respectively at the top of the P.M. speaker. Four red-headed transit bolts are provided in addition to the chassis fixing bolts, but these should be removed while the set is in use. **Removing Speaker.**—Free the speech coil leads between the two speakers from the cleats on the front of the cabinet; remove the four cheese-head bolts (with washers) holding each speaker to the sub-baffle.

VALVE ANALYSIS

Valve voltages and currents given in the table below are those quoted in the manufacturers' manual. Their receiver was switched to the M.W. band and the volume was at maximum, but there was no signal input. Voltages were measured with a 500 ohms-per-volt meter whose negative lead was connected to chassis.

Valve	Anode		Screen		Cath.
	V	mA	V	mA	V
V1 X148	250	1.7	90	3.0	1.0
	Oscillator				
V2 W148	120	0.2	90	1.7	2.6
	250				
V3 DH63	80	0.6	—	—	1.2
V4 KT61	225	39.0	250	0.6	3.4
V5 U70	315†	—	—	—	322.0

† Each anode, A.C.

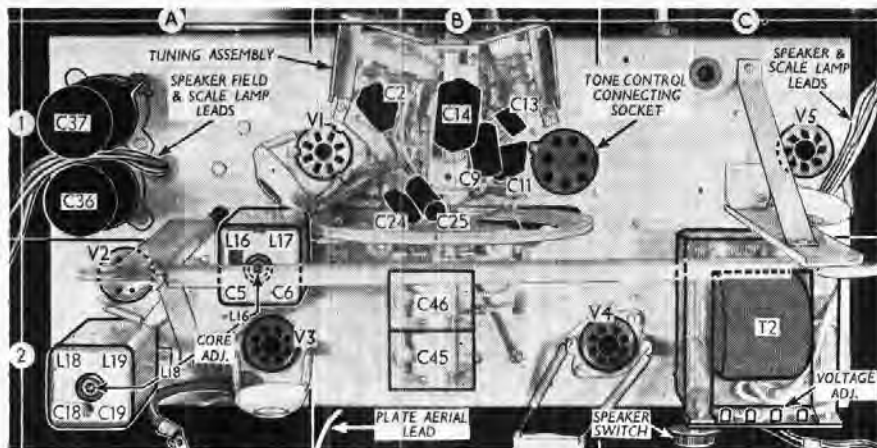

Plan view of the chassis. The tuning assembly, indicated at the top centre, is shown in situ. The tone control connecting socket is seen just to the right of the tuning assembly, on the chassis deck. The I.F. transformer primary adjustments are indicated here, and the secondaries in the under-chassis view. All the other alignment adjustments are shown in the sketch in col. 2 above.

When replacing, the energized speaker goes on the left when viewed from the rear, with its field tags on its left. The speech coil tags of the P.M. speaker should be at the top. The speaker leads from chassis should be connected as described previously.

It is important that these two speakers should be connected in phase with each other. The yellow lead between them should go to the positive (left-hand) tag on the P.M. speaker and the centre (hum neutralizing coil) tag on the right-hand side of the energized unit; the black lead goes to the negative tag on the P.M. speaker and the bottom tag on the energized speaker.

Removing Press-button Unit.—Unsolder the eleven leads connecting the unit with the main chassis;

from the base of the unit remove four self-tapping screws holding it to the front chassis member, and from the top, two more screws holding it to the bracing struts.

When replacing, the connecting points are numbered 1-11 in square boxes in our photograph of the unit and our circuit diagram.

Removing Tone Control Unit.—Pull off the press-button escutcheon and remove the 4BA screw (with washer) thus revealed, when the unit may be lifted out.

GENERAL NOTES

Switches S1-S8 are the waveband, pick-up and pre-set station switches, operated by eight press-buttons. They bear lettered suffixes which identify them and show their action, a, b, c, d or e indicating that they close when their button is pressed, and x, y, z indicating that they close when that button is released.

These switches are all mounted on the press-button switch unit, which is indicated in our photograph of the tuning assembly in col. 1 and shown in detail in the diagram in col. 4. S1e and S1z are operated by the S.W. button, but they are an external fitting to the switch unit.

S9, S10 are the speaker switches, in a 3-position unit mounted on the rear chassis member. In the fully anti-clockwise position of the control knob, S10 closes to connect the external speaker only; in the central position, both switches close; in the fully clockwise position, S9 closes to connect the internal speakers only.

S11 is the Q.M.B. mains switch, ganged with the volume control R14.

Scale Lamps.—These are three M.E.S. type lamps, with small clear spherical bulbs, rated at 6.3 V, 0.3 A.

External Speaker.—Two sockets are provided at the rear of the chassis for the connection of a low impedance (about 5Ω) external speaker. Switches S9, S10 in a 3-position unit permit either of all speakers to be connected.

Tone Control Plug.—The base and treble tone controls are mounted in a separate assembly connected to the main chassis by a standard British 7-pin valve base plug and socket on the chassis deck. The four connecting leads to the controls and the two to the scale lamp are numbered in our circuit diagram, and a diagram of the plug, viewed from the free ends of its pins, in inset beneath the circuit. Pin 5 is blank.

Chassis Divergencies.—In late versions, the tone compensator R13, C26 is omitted, R9 may be 680Ω R17 100Ω and R20 22kΩ.

Radiogram 1608 Modifications.—In the main, the chassis of the 1608 is like that of the 1117, and our diagram is applicable, but there are several differences. The two speakers are both P.M. types, and it is important that they should be linked in phase, the + tag of one going to the + tag of the other. The field coil is replaced by a smoothing choke situated on the chassis deck in front of the mains transformer. Additional negative feedback is introduced on gram only, C35 being switched out of circuit. The change-over is effected by the oscillator side of the gram P.B. switches, the chassis lead from T1 secondary going via the switch to chassis on gram only. The other secondary lead is connected via a 220Ω and a 100Ω resistor to chassis, and at the junction of these two resistors is connected the bottom end of R15 and C27, introducing feedback into V3 cathode circuit when the gram button is pressed. In addition, a 0.022 μF capacitor is introduced between C8 and S8a.

The pick-up is connected via a special matching circuit and an "extended range" circuit to the pick-up sockets of the receiver. The gramophone motor, which was originally of the hysteresis type and later a No. 2 rim drive model, is connected to the 205 V terminals of the mains transformer. The automatic record changer mechanism is type 35000N, which handles up to ten 10in or 12in records unmixed.

Under-chassis view. The tags of the speaker switch unit are identified here. Most of the components are mounted on two tag strip assemblies. Some components at top centre are mounted on the tuning assembly, which projects into the under-chassis compartment.

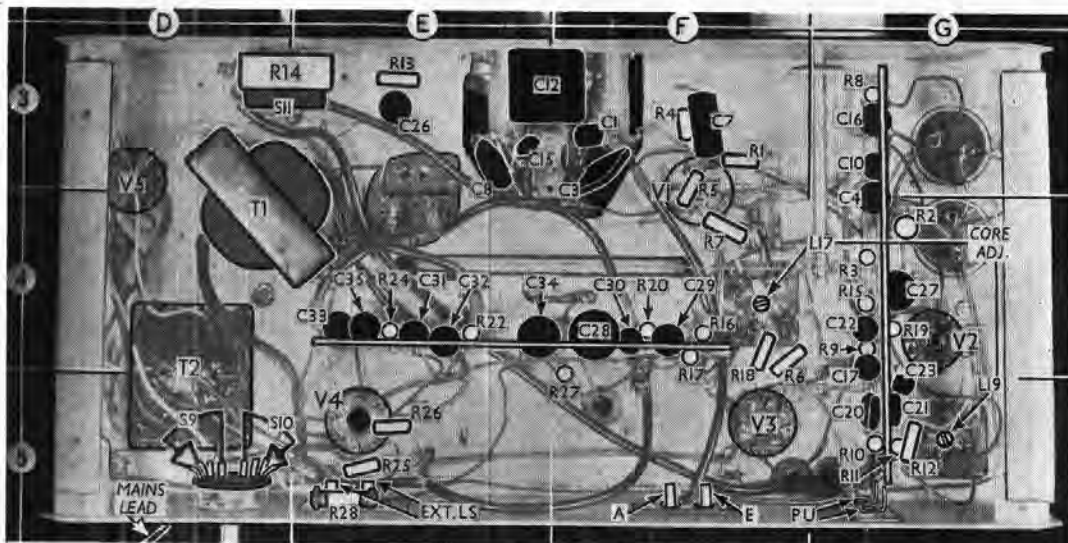

CIRCUIT ALIGNMENT

I.F. Stages—Switch set to M.W., turn volume control, tone controls and gang to maximum. Connect signal generator via a 0.05µF capacitor to control grid (pin 6) of V1 and chassis, feed in a 485 kc/s (645.16 m) signal and adjust the cores of L19, L18, L17 and L16 (location references A2, F4 and G5) for maximum output, reducing the input as the circuits come into line to avoid A.G.C. action. Repeat these adjustments.

R.F. and Oscillator Stages—These operations may be performed with the receiver in its cabinet, as all the adjustments can be made accessible from the front of the receiver by pulling off the press-button escutcheon moulding, but a substitute scale is printed on the back of the tuning drive drum.

This scale is divided into nine inches, each inch being sub-divided into sixteenths, and readings are taken against the red line on the metal bracket mounted immediately behind the drum. With the gang at maximum capacitance, the scale should read zero, and if necessary the bracket can be adjusted upon slackening its two fixing screws. On some early models, the calibration was reversed, maximum being at 9in. We quote these readings in brackets after the normal readings.

When the chassis is removed from the cabinet for alignment, the plate aerial should be disconnected and a 23pF capacitor connected between the aerial and earth sockets. Transfer the

(300 kc/s) signal and adjust C48 (J7) and C40 (I17) for maximum output. Tune to 1,850 m (77in (1 1/2in) on scale), feed in an 1,850 m (162 kc/s) signal and adjust the cores of L13 (J7) and L6 (H7) for maximum output. Repeat these adjustments.

Pre-set stations—A signal generator output may be used to set these adjustments roughly, but they should be subsequently adjusted on the stations they are intended to receive. After adjustment, the appropriate station name label should be inserted in the button, bottom edge first. The old one can be prised out with a knife blade under the right-hand edge.

Numbering from top to bottom, the pre-set press-buttons are: 1, 1,250-1,870 m; 2 and 3, 300-532 m; 4, 200-235 m. Then follow: 5, Gram; 6, L.W.; 7, M.W.; 8, S.W. The receiver should be allowed to warm up for fifteen minutes at the user's house before final adjustments are made.

DRIVE CORD REPLACEMENT

About 2ft of cord and 3ft 6in of wire are required for the tuning drive, and it is important that these should be of the correct type. They are obtainable from E.M.I. Sales and Service, Ltd., Sheraton Works, Greenford, Middlesex.

Make up a length of wire 39 1/2in overall with 1in loop at each end, soldering the wire before cutting. Slip one loop over the anchor on the drive drum, threading it through the groove slot, tie the cord to the loop at the free end, and run the cord as shown in the sketch below, finally tying off so that the tension spring is extended to about 1 1/2 times its relaxed length.

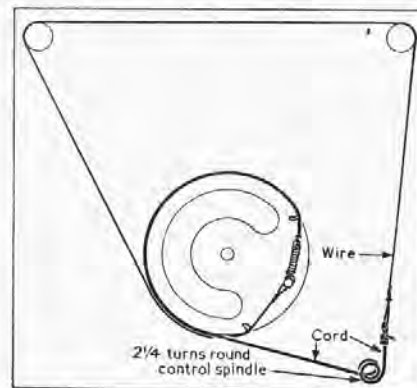

Sketch of the tuning drive system, drawn as seen from the rear of the chassis (neglecting obstructions) when the gang is at maximum.

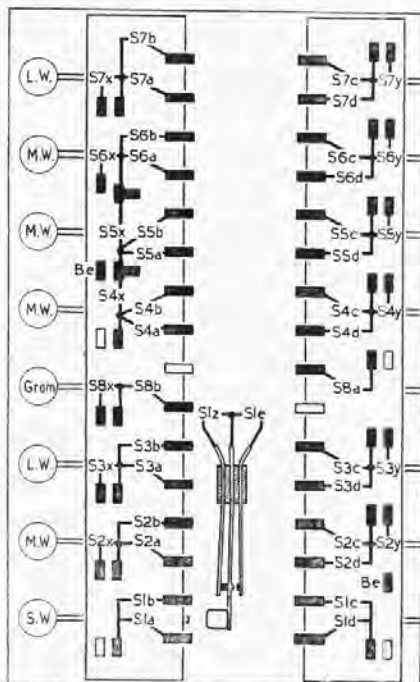

Diagrams showing the two sides of the press-button switch unit, drawn as seen from either side of the rear of the tuning assembly. The S1e, S1z attachment is operated by the S.W. button.

TV TECHNICAL FORUM Contributions Wanted

Contributions are invited from dealers, service engineers and manufacturers relating their experiences or passing on useful hints to the trade. The first of this series appeared on page 969 of our last issue.

Address contributions to the Technical Editor, The Wireless and Electrical Trader, Dorset House, Stamford Street, London, S.E.1. Half a guinea will be paid for each article used.

"Five" signal generator lead to the aerial socket, using a 400Ω resistor on S.W., or a 200 pF capacitor on M.W. and L.W., as a dummy aerial.

S.W.—Press S.W. button, tune to 50 m (8 1/2in (1in) on substitute scale), feed in a 50 m (6 Mc/s) signal and adjust the cores of L11 (Js) and L4 (H8) for maximum output. Tune to 17.8 m (3 1/2in (8 1/2in) on scale), feed in a 17.8 m (16.86 Mc/s) signal and adjust G38 (H8) for maximum output. Repeat these adjustments.

M.W.—Press M.W. button, tune to 210 m (1in (5in) on scale), feed in a 210 m (1,429 kc/s) signal and adjust C47 (J6) and C39 (H7) for maximum output. Tune to 510 m (7 1/2in (15 1/2in) on scale), feed in a 510 m (588 kc/s) signal and adjust the cores of L12 (J7) and L5 (H8) for maximum output. Repeat these adjustments.

L.W.—Press L.W. button, tune to 1,000 m (1 1/2in (7 1/2in) on scale), feed in a 1,000 m