

"TRADER" SERVICE SHEET
1025

H.M.V. 1122

Covering Also Models 1123, 1615 and 1616

THREE wavebands are covered by the H.M.V. 1122, a 4-valve (plus rectifier) superhet designed to operate from A.C. mains of 105-255 V., 50-100 c/s. The waveband ranges covered are 16.3-51.7 m, 187-575 m and 900-2,000 m.

The 1123 is a similar receiver provided with the additional facility of press-button tuning for four pre-set stations, the R.F. and oscillator circuits being shown separately in our circuit diagram below. The 1615 is a table autoradiogram employing a slightly modified 1122 chassis, and the 1616 is a console autoradiogram version of the 1122. This Service Sheet was prepared from a 1122.

The following description of the circuit first deals with the R.F. and oscillator stages of the three models that have manual tuning only, then those of the press-button model. From the I.F. amplifier onwards the circuit is common to all four models.

Release dates and original prices: 1122, September 1950, £21 4s 10d; 1123, August 1951, £24 3s 4d; 1615, August 1951, £40 5s 10d; 1616, June 1951, £57 11s 5d. Purchase tax extra.

CIRCUIT DESCRIPTION

In the non-press-button version of this receiver, aerial input is via coupling coils L1, L2, L3 to single tuned circuits L4, C30 (S.W.), L5, C30 (M.W.) and L6, C30 (L.W.) which precede triode hexode valve (V1, Marconi X78) which operates as frequency changer with internal coupling. C1 shunts L2 to move its resonance outside the M.W. band, and C2 shunts L3, giving image rejection on L.W. A plate aerial is provided for use in areas of good signal

strength and can be connected by a plug to the aerial socket.

Oscillator anode coils L9 (S.W.), L10 (M.W.) and L11 (L.W.) are tuned by C34. Parallel trimming by C31 (S.W.), C32 (M.W.) and C13, C33 (L.W.); series tracking by C10 (S.W.), C11 (M.W.) and C12 (L.W.). Reaction coupling from grid across the common impedance of tracker C12 (L.W.) and by L7 (S.W.), L8 (M.W.), S.W. stabilization by R5.

In the press-button model the waveband switch has a fifth position, marked PB, which brings into circuit the press-button switch unit. The circuit of the R.F. and oscillator section of the press-button model is shown on the left of the main circuit diagram, the I.F., A.F. and power circuits being the same for both models.

All the switches associated with the press-button unit have been coded to indicate their action when a button is pressed. Thus a switch bearing the suffix a, b, c or d closes when its button is pressed, while one bearing an x opens. When the button is released these actions are reversed.

Each button operates two sets of switches, one in the aerial circuit, which substitutes pre-set capacitors C35 (L.W.) or C36, C37 or C38 (M.W.) in place of the manual tuning capacitor C30; and one in the oscillator circuit, which replaces the coils and tuning capacitor with pre-set coils L17 (L.W.) or L18, L19 or L20 (M.W.). All the switches in both groups operated by a given button bear the same number, the individual switches being identified by their suffixes.

The changeover from manual tuning to automatic tuning is effected by the switches S32, S34, and S36 in the aerial circuit, which close in the PB position of the waveband control, and S35, which opens. In the oscillator circuit, the

changeover is effected by S40 and S47, which close, and S48, which opens. S50 and S51 close in the PB position to short-circuit the two sections of the tuning gang.

Second valve (V2, Marconi W77) is a variable-mu R.F. pentode operating as intermediate frequency amplifier with tuned transformer couplings C6, L12, L13, C7 and C16, L14, L15, C17.

Intermediate frequency 470 kc/s.

Diode signal detector is part of double diode triode valve (V3, Marconi DH77). Audio frequency component in rectified output is developed across volume control R11, which acts as diode load, and is passed via C19 to grid of triode section. Provision is made for the connection of a gramophone pick-up across R11 via S21. S19 and S20 open in the Gram position of the waveband switch to mute radio. I.F. filtering by C18, R9 and C20. Second diode of V3 is connected to chassis.

D.C. potential developed across R11 is fed back as bias via decoupling circuit R10, C9 to F.C. and I.F. valves giving automatic gain control.

Resistance-capacitance coupling between V3 triode and pentode output valve (V4, Marconi N78) by R13, C21 and R14. Tone correction by C24 and the negative feed-back voltage developed across R18. Tone control by R17 and C23.

Provision is made for the connection of a low impedance external speaker across T1 secondary, and when this is in use the internal speaker may be muted by pulling out the speaker plug from its socket.

H.T. current is supplied by full-wave rectifying valve (V5, Marconi U74). Smoothing by resistors R16, R19 and electrolytic capacitors C22, C25, C26.

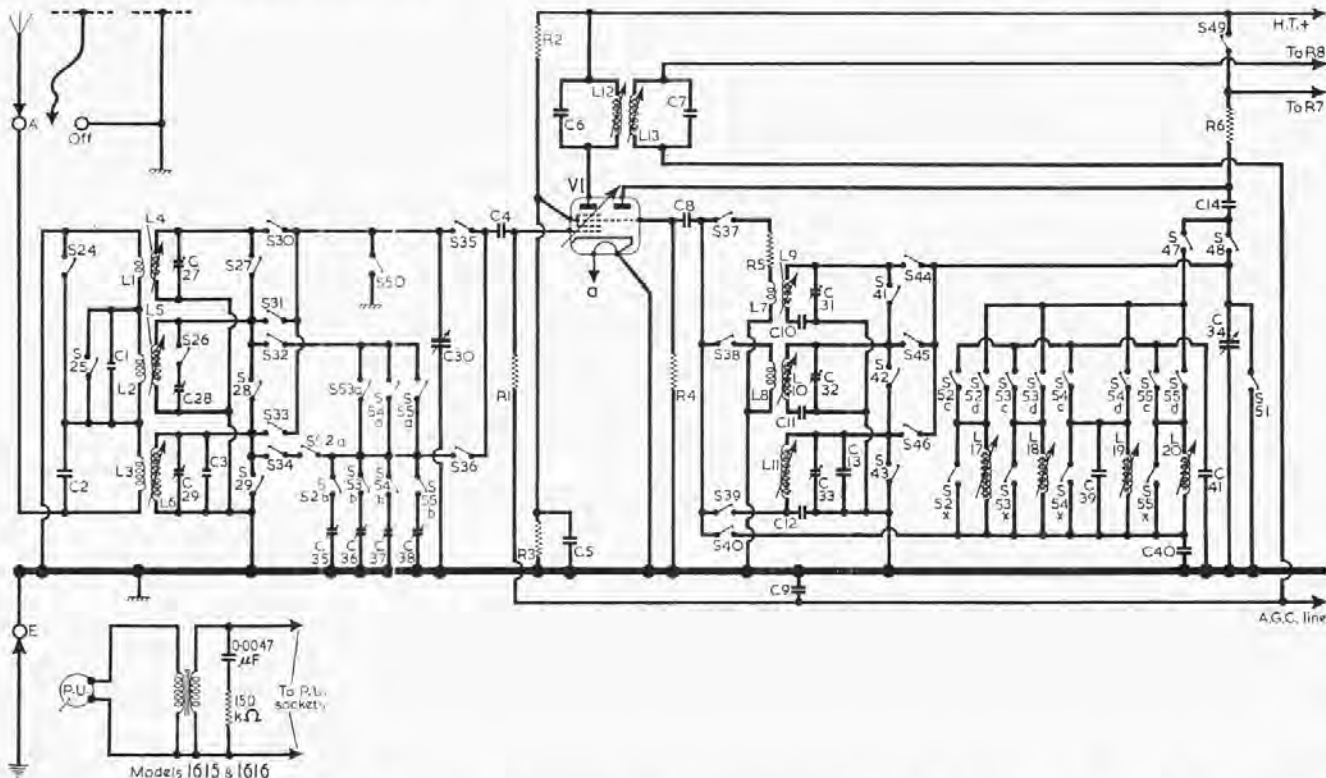

Circuit diagram of the aerial and oscillator tuning circuits, as they are in the press-button model. An "accidental" switch (S0 in the switch diagrams) occurs between S25 and S34. In the bottom left-hand corner is a diagram of the pick-up transformer in the ARG models.

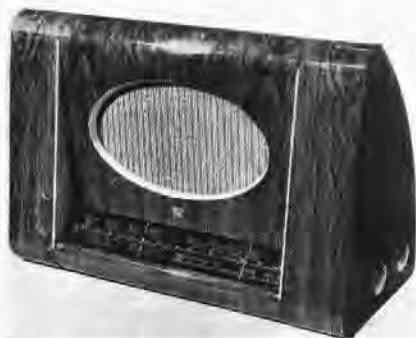

The appearance of the H.M.V. 1122 receiver.

COMPONENTS AND VALUES

RESISTORS		Values	Locations
R1	V1 C.G.	470kΩ	F3
R2	H.T. potential divider	15kΩ	F3
R3		12kΩ	G3
R4	V1 osc. C.G.	22kΩ	G3
R5	Osc. stabilizer	100kΩ	G4
R6	Osc. anode load	22kΩ	G3
R7	V2 S.G. feed	15kΩ	F4
R8	V2 C.G. stopper	10kΩ	F3
R9	I.F. stopper	100kΩ	F4
R10	A.G.C. decoupling	1.5MΩ	F3
R11	Volume control	500kΩ	D3
R12	V3 C.G.	3.3MΩ	F4
R13	V3 anode load	100kΩ	F4
R14	V4 C.G.	220kΩ	F4
R15	V4 C.G. stopper	10kΩ	E4
R16	H.T. smoothing	2kΩ	E4
R17	Tone control	20kΩ	D4
R18	V4 G.B.	200Ω	E4
R19	H.T. smoothing	1kΩ	E3

CAPACITORS		Values	Locations
C1	Aerial shunts	22pF	G4
C2		220pF	G3
C3		68pF	G3
C4	V1 C.G.	220pF	G3
C5	V1 S.G. decoup.	0.1μF	G3
C6	1st I.F. trans. tuning	100pF	B1
C7		100pF	B1
C8	V1 osc. C.G.	100pF	G3
C9	A.G.C. decoupling	0.047μF	F3
C10	S.W. osc. tracker	3,900pF	G4
C11	M.W. osc. tracker	510pF	G3
C12	L.W. osc. tracker	180pF	G3
C13	Osc. trimmer	100pF	G3
C14	Osc. anode coup.	100pF	G4
C15	V2 S.G. decoup.	0.1μF	F3
C16	2nd I.F. trans. tuning	100pF	B2
C17		100pF	B2
C18	I.F. by-pass	100pF	F4
C19	A.F. coupling	0.047μF	F4
C20	I.F. by-pass	220pF	F4
C21	A.F. coupling	0.047μF	F4
C22*	H.T. smoothing	16μF	E3
C23	Part tone control	0.05μF	E4
C24	Tone corrector	0.005μF	E4
C25*	H.T. smoothing	32μF	E3
C26*		32μF	E3
C27†	S.W. aerial trim.	30pF	F4
C28†	M.W. aerial trim.	30pF	F4
C29†	L.W. aerial trim.	30pF	F3
C30†	Aerial tuning	—	A2
C31†	S.W. osc. trimmer	30pF	A2
C32†	M.W. osc. trimmer	30pF	A1
C33†	L.W. osc. trimmer	30pF	A1
C34†	Oscillator tuning	—	A2
C35†	L.W. pre-set	135pF	—
C36†	M.W. pre-set	450pF	—
C37†	M.W. pre-set Model	450pF	—
C38†	M.W. pre-set 1123	450pF	—
C39	M.W. trim. only	47pF	—
C40	Tracker	220pF	—
C41	Tuner	330pF	—

OTHER COMPONENTS		Approx. Values (ohms)	Locations
L1	Aerial coupling coils	0.1	G4
L2		20.0	G4
L3		62.0	G3
L4	Aerial tuning coils	0.1	G4
L5		3.0	G4
L6	Oscillator reaction coils	25.0	G3
L7		0.1	G4
L8	Oscillator tuning coils	8.9	G3
L9		0.5	G4
L10	1st I.F. trans.	3.5	G3
L11		7.0	G3
L12	2nd I.F. trans.	5.0	B1
L13		5.0	B1
L14	Speech coil	5.0	B2
L15		5.0	B2
L16	L.W. pre-set Model	3.0	—
L17		10.65	—
L18	M.W. pre-set 1123	5.0	—
L19		2.5	—
L20	M.W. pre-set	2.5	—
T1		310.0	B2
T2	Mains H.T. sec. trans.	0.1	C2
		900.0	—
S1-	Waveband switches	—	G4
S21		—	—
S22	Mains sw., g'd R11	—	D3
S23		—	—
S24-	W/b switches	—	—
S51		—	—
S52-	Pb switches only	1123	—
S55		—	—
F1, F2	1 amp fuses	—	B2

* Electrolytic. † Variable. ‡ Pre-set.

If the component numbers given in the accompanying tables are used when ordering replacement parts, dealers are advised to mention the fact on the order, as these numbers may differ from those used in the manufacturers' diagram.

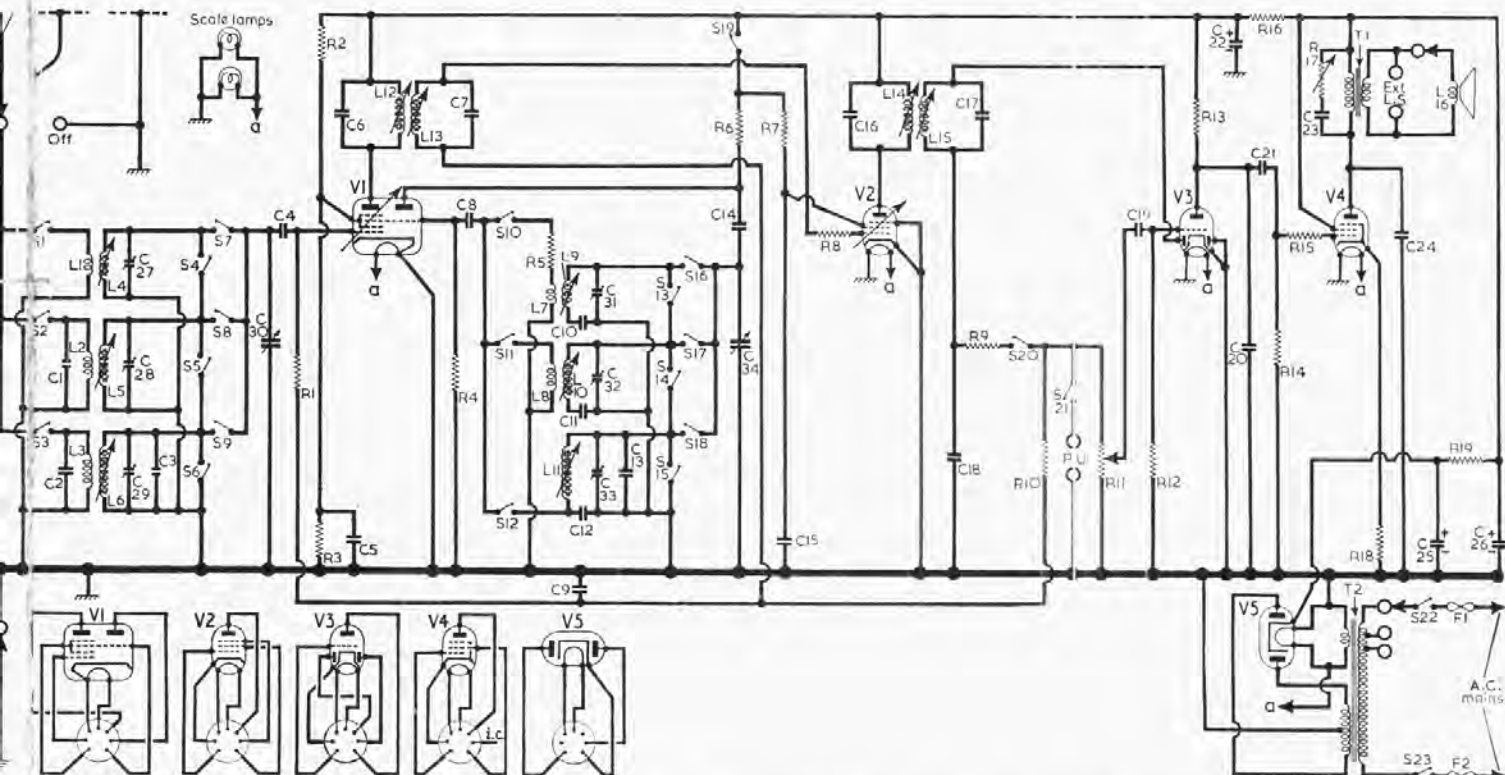

Complete circuit diagram of the H.M.V. 1122 receiver. From V2 onwards it applies also to the 1123 diagram, whose variable and pre-set tuning circuits are shown in the separate diagram on the left. The plate aerial plug goes in the "off" socket when not required.

Model 1122 Switch Units

Switches	L.W.	M.W.	S.W.	Gram.
S21			o	
S22			o	
S23	o			
S24	o			
S25	o			
S26	o			
S27	o			
S28	o			
S29	o			
S30	o			
S31	o			
S32	o			
S33	o			
S34	o			
S35	o			
S36	o			
S37	o			
S38	o			
S39	o			
S40	o			
S41	o			
S42	o			
S43	o			
S44	o			
S45	o			
S46	o			
S47	o			
S48	o			
S49	o			
S50	o			
S51	o			
S52	o			

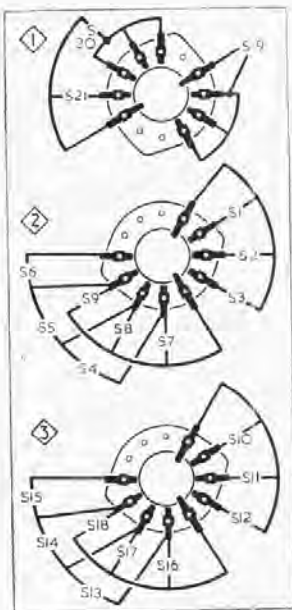

Diagrams of the waveband switch units of the model 1122. They are drawn as seen in the direction of the arrows in our underside view of the chassis.

GENERAL NOTES

Switches.—In the non-automatic tuning models, which are represented by the main circuit diagram, S1-S18 are the waveband switches and S19-S21 are the radio/gram change-over switches, ganged in three rotary units beneath the chassis. These are indicated in our underside drawing of the chassis, where they are identified by the numbers 1, 2, 3 in diamond surrounds, with arrows to show the direction in which they are viewed in the diagrams in col. 1, where they are shown in detail.

The table in col. 1 gives the switch positions for the four control settings, starting from the fully anti-clockwise position of the control knob. A dash indicates open, and o, closed.

In the press-button version, with automatic tuning, these three switch units are replaced by three five-position units, embracing the switches S24-S51. These are seen in the left-hand circuit diagram overleaf. The units are shown in detail in col. 3 on this page. The associated table appears above it.

S52a, b, c, d, x—S55a, b, c, d, x are the press-button switches, which are brought into circuit in the fifth position of the waveband control. Their action is fully explained under "Circuit Description."

Scale Lamps.—These are two "Vitality" lamps, with clear tubular bulbs and M.E.S. bases, rated at 6.8 V, 0.3 A.

External Speaker.—Two sockets are provided at the rear of the chassis for the connection of a low impedance (about 5Ω) external speaker. A third socket, on their right, is for the internal speaker muting plug.

Plate Aerial.—This is part of a metallic coating on the inside of the back cover. The other part makes contact with the cover fixing bracket on the cabinet, and a lead connects this bracket to chassis, earthing it.

The metallic coating is divided into two parts. The insulated part is the plate aerial, and it has attached to it a plug on a flying lead, which can be plugged into the aerial socket when required. When not required, the plug is inserted in a socket labelled "Plate aerial off" in the back cover, which is in contact with the earthed section of the coating. The whole coating then behaves as an earthed screen.

Associated Models

Our work was performed on a model 1122 receiver, whose circuit is shown in our main circuit diagram overleaf. To the left of this diagram is the R.F. and oscillator circuit of the 1123, which is equipped with a press-button tuning unit for four pre-set stations. The 1123 is otherwise identical with the 1122.

Model 1615 is a table autoradiogram employing a type 45000AS record changer, which plays ten 10in or 12in records unmixed, with a No. 2 rim drive motor. Its chassis is basically that of the 1122, but the order of control knob sequence is different, the waveband and tuning controls being transposed. The drive cord system is therefore different.

The chassis is mounted end-on to the front of the cabinet, and the other two controls, from the far end, are attached by flexible connecting leads.

Model 1616 is a console autoradiogram employing a type 45000AS record changer with a type 26200P hysteresis motor. The chassis is like that in the 1122, with control knobs at the sides.

A sketch of the drive cord system used in the

Model 1123 Switch Units

Switches	PB	L.W.	M.W.	S.W.	Gram
S20	o	o	o	o	
S21					o
S24		o			
S25					
S26			o		
S27					
S28					
S29			o		
S30					
S31			o		
S32					
S33		o			
S34	o				
S35			o		
S36					
S37			o		
S38					
S39		o			
S40					
S41					
S42					
S43			o		
S44					
S45			o		
S46		o			
S47					
S48		o			
S49			o		
S50					
S51					
S52		o			
S53					
S54					
S55					
S56					
S57					
S58					
S59					
S60					

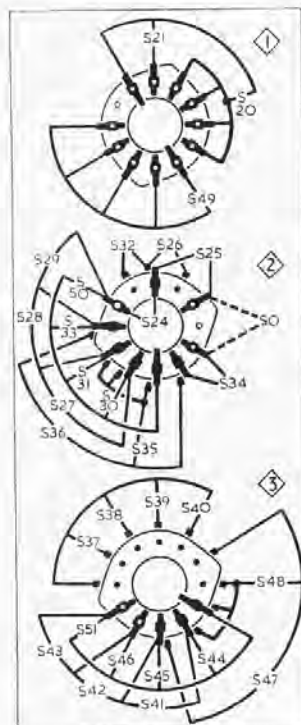

Diagrams of the waveband switch units in the 1123, drawn as seen in the directions of the arrows in our underside view of the chassis. S0 (shown dotted) is an "accidental" switch, not shown in the circuit diagram.

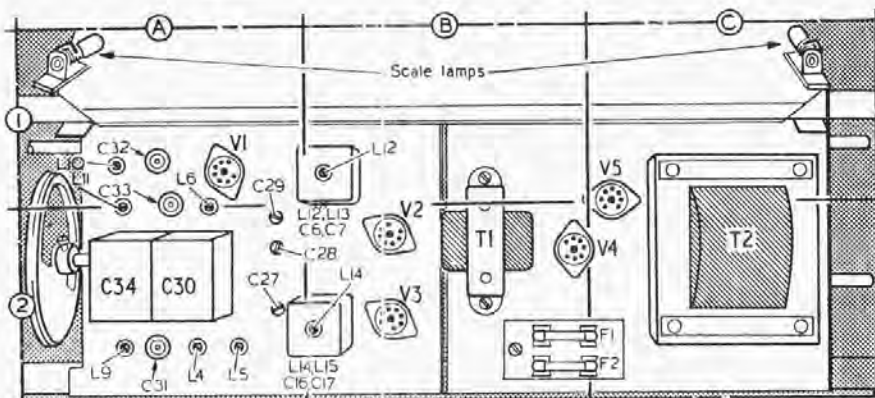

Plan view of the chassis of the 1122. In the other associated models there is no appreciable difference. All five valves are fitted with retaining screening covers.

1615 appears in col. 6. It consists of two quite separate cords, each with its own tension spring, but they are coupled together by a linking clamp so that the gang drive cord also drives the cursor drive cord.

The two autoradiograms are provided with a matching transformer between the pick-ups and the pick-up sockets. This transformer is not shown in our circuit diagram, but its circuit is inset at the bottom left-hand corner of the press-button circuit diagram overleaf.

Underside view of the 1122 chassis. There are differences in the associated models, but they are very small except in the case of the 1615, where the tone and volume controls are not mounted on the chassis but are connected by flexible cables.

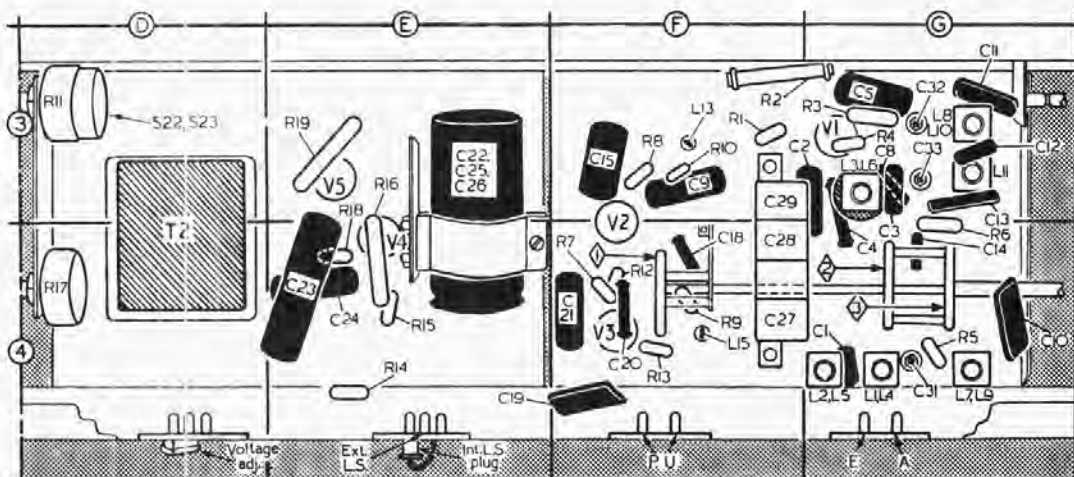

CIRCUIT ALIGNMENT

As the tuning scale is fixed to the cabinet, the following alignment instructions should be carried out with the chassis in the cabinet, core and trimmer adjustments being made accessible upon removing the back and base cover. Connect the signal generator output via a 0.01 µF capacitor in the "live" lead, to control grid (pin 1) of V1 and chassis.

I.F. Stages.—Switch set to M.W. and turn gang to minimum. Feed in a 470 kc/s (638.3 m) signal and adjust the cores of L15 (location reference F4), L14 (B2), L13 (F3) and L12 (B1) for maximum output, reducing the input as the circuits come into line to avoid A.G.C. action. Repeat these adjustments.

R.F. and Oscillator Stages.—Transfer signal generator leads, via a dummy aerial, to A and E sockets. Check that with the gang at maximum capacitance the cursors coincide with the ends of the tuning scales. The cursors can be individually adjusted by sliding them along the drive cord.

S.W.—Switch set to S.W., tune to 50 m, feed in a 50 m (6 Mc/s) signal and adjust the cores of L9, L4 (A1). Tune set to 16.8 m, feed in a 16.8 m (17.8 Mc/s) signal and adjust C31, C27 (A2) for maximum output. Repeat these adjustments.

M.W.—Switch set to M.W., tune to 510 m, feed in a 510 m (588 kc/s) signal and adjust the cores of L10 (A1) and L5 (A2) for maximum output. Tune to 186.9 m, feed in a 186.9 m (1,605 kc/s) signal and adjust C32 (A1) for maximum output. Tune set to 210 m, feed in a 210 m (1,427 kc/s) signal and adjust C28 (A2) for maximum output while rocking the gang for optimum results. Repeat these adjustments.

L.W.—Switch set to L.W., tune to 1,850 m, feed in a 1,850 m (162 kc/s) signal and adjust the cores of L11, L6 (A1) for maximum output. Tune set to 1,000 m, feed in a 1,000 m (300 kc/s) signal and adjust C33 (A1) and C29 (A2) for maximum output.

Pre-set stations, Model 1123.—A signal generator output may be used to set these adjustments roughly, but they should be subsequently adjusted on the stations they are intended to receive.

Numbering from left to right the pre-set pres-tuners are: 1, 1,175-2,000 m; 2, 330-510 m; 3, 373-400 m; 4, 187-300 m. The receiver should be allowed to warm up for fifteen minutes at the user's house before final adjustments are made. If adjustments are made during alignment to L5 or L6, the pre-set trimmer capacitors should be readjusted.

VALVE ANALYSIS

Valve voltages and currents given in the table below are those measured in our receiver when operating from A.C. mains of 230 V. The set was tuned to the highest wavelength end of M.W., and the volume control turned to maximum, but there was no signal input.

Voltage readings were measured with an Avo Electronic Test Meter, and as this instrument draws no appreciable current, allowance must be made for the current drawn by other meters. Chassis was the negative connection.

Valve	Anode		Screen		Cath.
	V	mA	V	mA	
V1 X78	168	1.3	64	1.8	—
	Oscillator				
	90	4.0			
V2 W77	168	8.2	135	2.3	—
V3 D1177	78	0.8	—	—	—
V4 X78	210	22.0	218	3.7	4.7
V5 U78	255†	—	—	—	280.0

† A.C. voltage.

DRIVE CORD REPLACEMENT

Models 1122, 1123, 1616.—About six feet of nylon-braided glass yarn is required for a new tuning drive cord, a single length being employed for both gang and cursor drives. The course is shown in the sketch in col. 4, where the system is drawn as seen in our sample chassis of the 1122 when viewed from the front right-hand corner of the chassis when the gang is at maximum capacitance.

First tie a loop about 3/8 in diameter at one end of the cord, hook it to the anchorage provided and pass the cord through the rim of the gang drum to the external groove, and run the cord as shown in the sketch, pulling against the gang stop to hold the cord in position. Finally tie off the free end to the tension spring so that the spring is extended to about one and

a half times its relaxed length when hooked to the anchorage.

The cursors can be fitted after running the cord, and should be adjusted individually by sliding them along the cord. With the gang at maximum capacitance they should coincide with the long wavelength ends of their respective tuning scales.

Model 1615.—In this model, two separate cords are required for the gang drive and cursor drive. The gang drive cord is driven from the tuning control spindle, but the cursor drive cord is driven by a linking clamp which couples the cursor cord to the gang cord. The complete system is shown in the sketch below, which is reproduced from a drawing in the maker's service manual, where it will be seen that each cord has its own tension spring.

DISMANTLING THE SET

Removing Chassis.—Remove two knobs from each side of cabinet (pull off); unsolder leads from speech coil tags on speaker; release earth lead from rear left-hand corner of chassis by removing self-tapping screw; remove four 2BA chassis bolts (with plain and lock-washers) and withdraw chassis. When replacing, the yellow speaker lead is connected to the speech coil tag marked +.

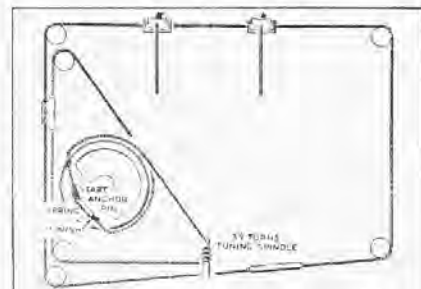

Reproduction of the drive cord system of the Model 1615 table autoradiogram, as it is shown in the maker's service manual. Two separate cords are used, the gang cord being driven and the cursor cord being clamped to it. The cursor cord is provided with its own tension spring.

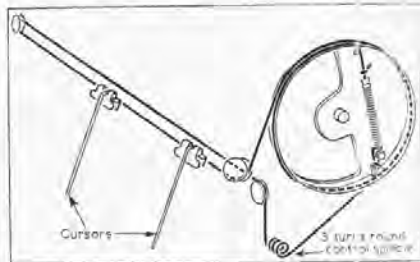

Sketch of the drive cord system, drawn as seen in our sample chassis when viewed from the front right-hand corner of the chassis with the gang at maximum capacitance. It is the same in Models 1122, 1123 and 1616.