

www.radio-workshop.co.uk

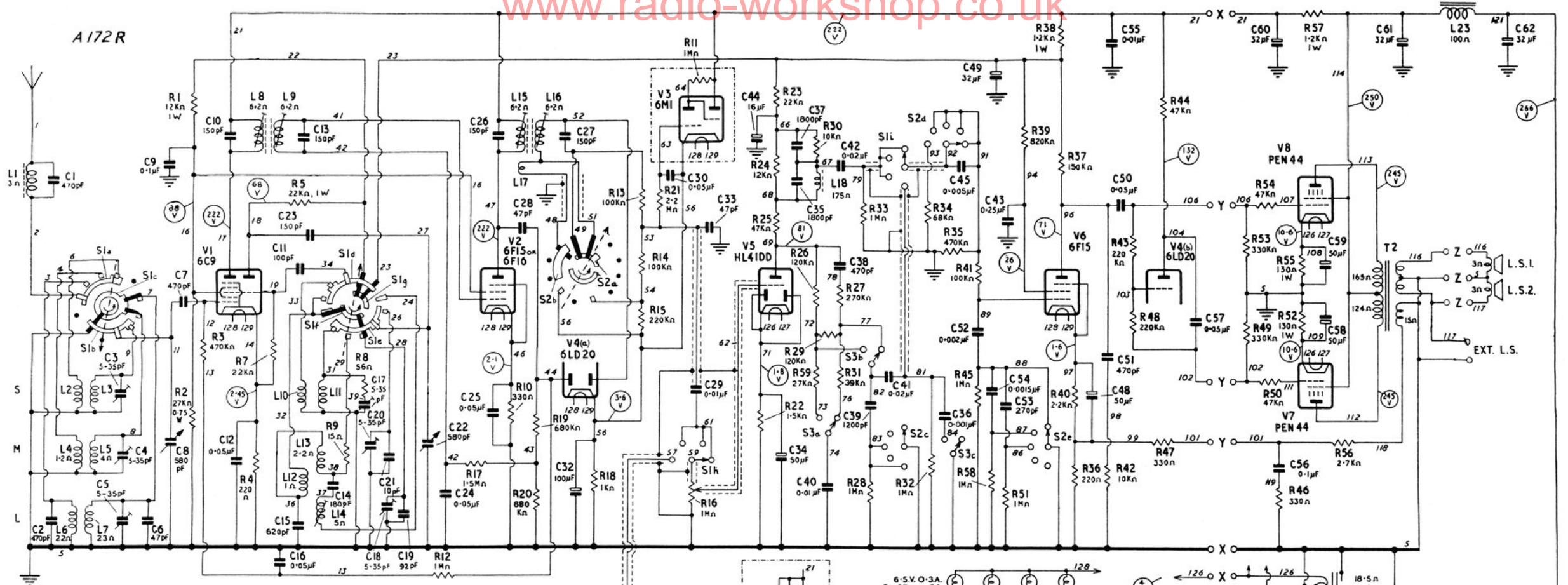

ALL VOLTAGES WERE MEASURED WITH A 500Ω/V METER UNDER NO-SIGNAL CONDITIONS ON THE MEDIUM WAVEBAND.
 S1 (a-i) IS SHOWN IN THE 'S' POSITION.
 S2 (a-e) " " " " " MIN. TOP MAX SELECTIVITY POSITION.
 S3 (a-c) " " " " " 78 R.P.M. POSITION.
 ALL SWITCHES ROTATE ANTI CLOCKWISE FROM THE POSITIONS SHOWN AND ARE VIEWED FROM THE REAR OF THE RECEIVER. THE BLACK CONTACTS AND INNER ROTORS ARE ON THE HIDDEN SIDES OF THE WAFERS.

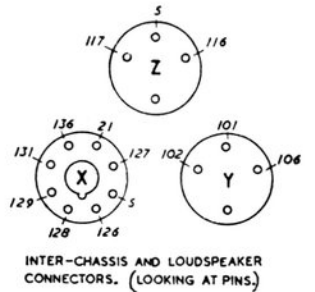
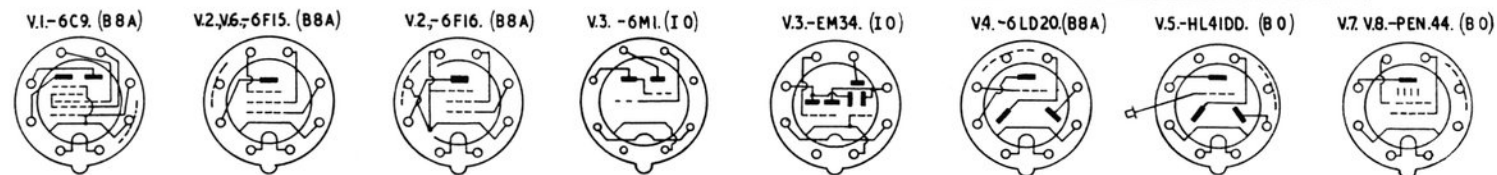
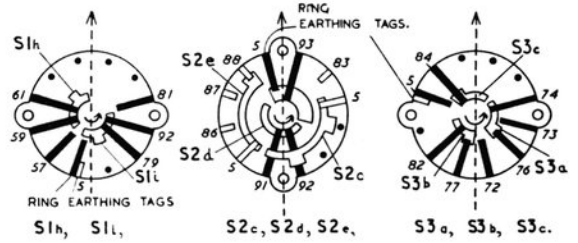
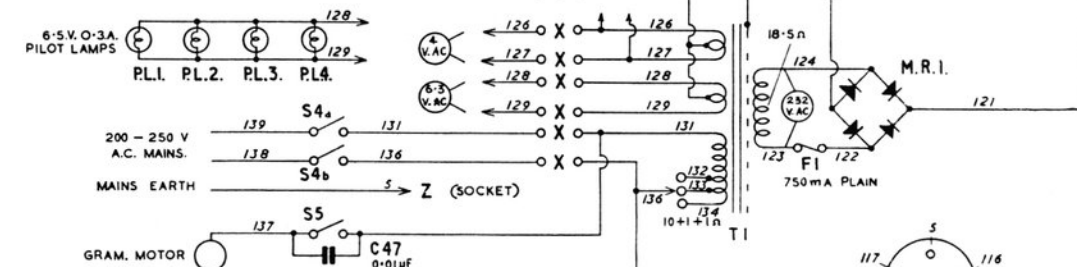
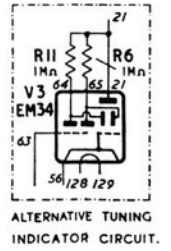
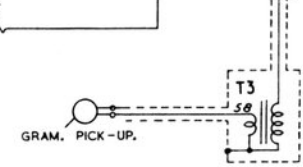

THE ARROW HEAD ON THE BROKEN LINE INDICATES THE TOP OF THE SWITCH WAFER AS SEEN FROM THE REAR WITH THE CHASSIS INVERTED.

Fig. 5.

SUBJECT TO ALTERATION WITHOUT NOTICE. ISSUE F.