

"TRADER" SERVICE SHEET

895

MULLARD MAS221

3-Band A.C. Superhet

A PLATE aerial is provided in the Mullard MAS221 receiver for use in temporary locations, a jack-type switch associated with the aerial socket converting it to a screen when an external aerial is connected.

The receiver is a 4-valve (plus rectifier) 3-band superhet designed to operate from A.C. mains of 100-260 V, 50-100 c/s. The S.W. range is 16.3-51 m, the aerial circuit operating aperiodically on this band. The other ranges are 192-560 m and 900-2,000 m.

Release date and original price: July 1948; £20 7s. 11d. plus purchase tax.

CIRCUIT DESCRIPTION

External aerial input is coupled, via the I.F. rejector **L1**, **C1** and capacitive potential divider **C2**, **L2**, **C3**, **R2**, to single tuned circuits **L3**, **C34** (M.W.) and **L4**, **C34** (L.W.). A resistor **R1** shunts the input circuit to prevent modulation hum. For S.W. operation the M.W. aerial coil **L3** is shunted by a S.W. R.F. choke **L2**,

via **S2**, and the tuning capacitor **C34** is disconnected due to the opening of **S5**, so that the input circuit is aperiodic.

An internal plate aerial, operative on all bands, is provided and coupled to the aerial circuits via the low potential ends of the trimmers **C32**, **C33**, but when an external aerial is employed **S14**, a jack-type switch associated with the **A** socket, closes to connect these trimmers across their tuned circuits and earth the plate aerial, which then acts as a screen.

First valve (**V1**, Mullard metallized **ECH35**) is a triode-hexode operating as frequency changer with internal coupling. Triode oscillator grid coils **L5** (S.W.), **L6** (M.W.), **L7** (L.W.) are tuned by **C35**, with parallel trimming by **C36** (S.W.), **C37** (M.W.) and **C11**, **C38** (L.W.). Tracking by **C10** (M.W.) and **C10**, **C12** in series (L.W.); reaction coupling from anode, via **C13**, is inductive, due to **L8**, on S.W., and capacitive, due to the common impedance of **C10** in grid and anode circuits, on M.W. and L.W., **S12** and **S13** then being open.

Second valve (**V2**, Mullard metallized

EF30) is a variable-mu R.F. pentode operating as intermediate frequency amplifier with tuned-transformer couplings **C6**, **L9**, **L10**, **C7** and **C16**, **L11**, **L12**, **C17**. Intermediate frequency 470 kc/s.

Diode second detector is part of double diode triode valve (**V3**, Mullard metallized **EBC33**). Audio frequency component in rectified output is developed across manual volume control **R13**, which is also the diode load resistor, and passed via **C20** and **R15** to grid of triode section, which operates as A.F. amplifier. I.F. filtering by **C18**, **R11** in diode circuit, and provision for the connection of a gramophone pick-up across **R13** via **S16**, with which is associated the radio muting switch **S15**. Three-position negative feedback tone control is provided by **C21**, **S17**, **S18**, **C22** which enable **V3** anode output voltages to be fed back to its control grid circuit.

Second diode of **V3**, fed from **V2** anode via **C19**, provides D.C. potential which is developed across load resistor **R19** and fed back through a decoupling circuit **R12**, **C14** as G.B. to F.C. and I.F. valves, giving automatic gain control.

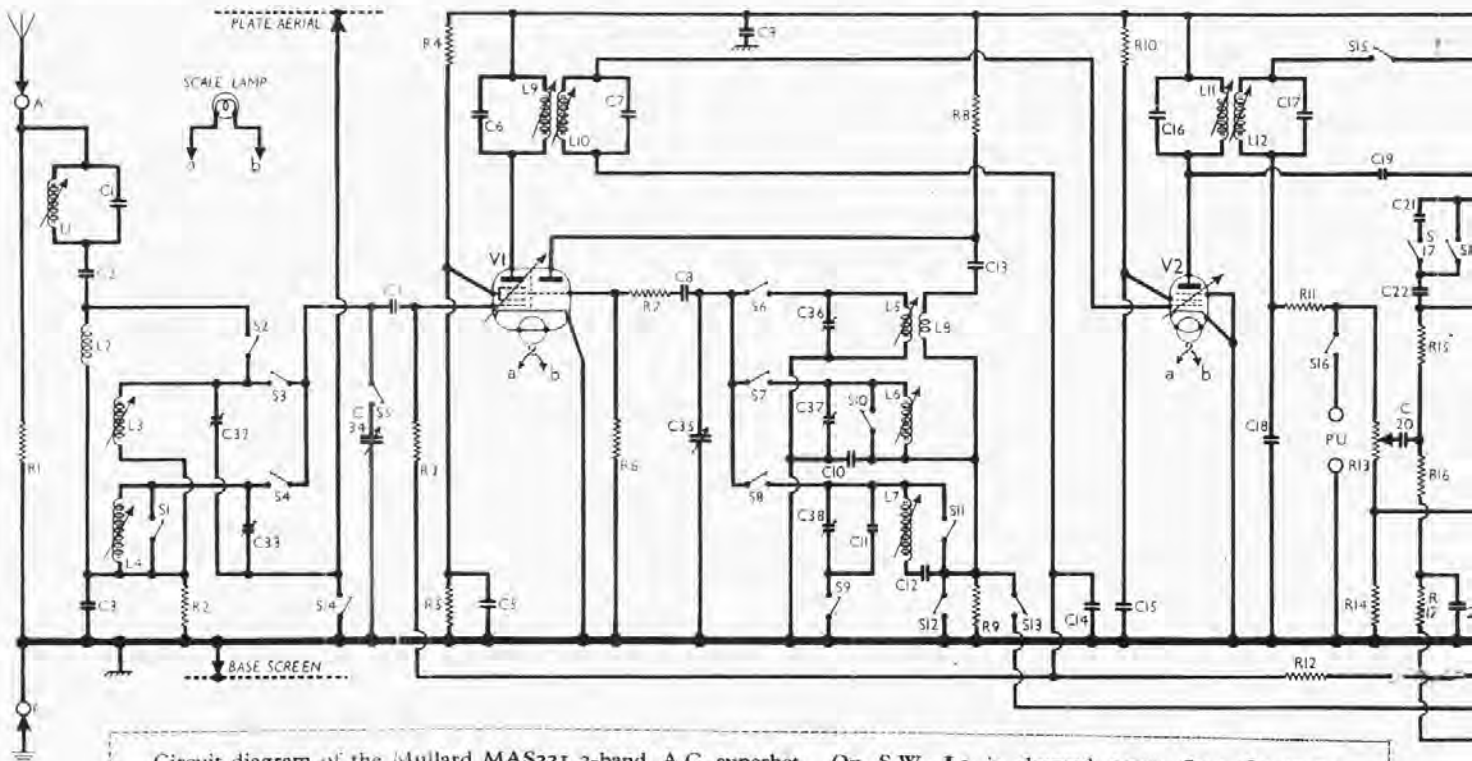

Circuit diagram of the Mullard MAS221 3-band A.C. superhet. On S.W., **L2** is shunted across **L3**; **S5** opens, and the aerial circuit is aperiodic. The insertion of the external aerial plug automatically closes **S14**, connecting the trimmers **C32**, **C33** and the plate aerial to chassis. 3-position tone control is provided by feedback coupling between the control grids of **V4** and **V3**. Another feedback circuit **R26**, **R27**, **R28**, **C29** provides tone correction, while hum neutralising voltages are applied by **R25**, **C27**. The feedback coupling is modified on S.W. by the closing of **S12**, **S13**.



The Mullard MAS221 A.C. superhet.

Resistance-capacitance coupling by **R18**, **R22**, **C24**, **R23**, via grid stopper **R24**, between **V3** triode and pentode output valve (**V4**, Mullard **EL33**). Fixed tone correction by **C26** in anode circuit.

A.F. voltages developed across **T1** secondary winding are applied to a potential divider network **R27**, **R28**, **C29**, tapped off, and fed back through **R26**, **C28**, **R14**, to **V3** grid circuit to improve the A.F. response on M.W. and L.W., and a small proportion of the ripple voltage present on the H.T. + line is also fed to this point via **R25**, **C27** to neutralize residual hum. The response of the circuit is modified on the S.W. band, when **S12**, **S13** close and short-circuit **C29**.

H.T. current is supplied by full wave rectifying valve (**V5**, Mullard **AZ31**). Smoothing by resistor **R29** and electrolytic capacitors **C30**, **C31**, but the H.T.

supply for **V4** anode is obtained direct from the rectifier filament. Fixed G.D. for **V3**, **V4** and A.G.C. delay voltage is provided by the drop across **R20**, **R21** in the H.T. negative lead to chassis. H.T. circuit R.F. filtering by **C9**.

COMPONENTS AND VALUES

RESISTORS		Values (ohms)	Locations
R1	Aerial shunt ...	5,600	M5
R2	Aerial coupling ...	10,000	L4
R3	V1 hex. C.G. ...	1,000,000	B2
R4	V1 S.G. H.T. feed {	22,000	L6
R5	potential divider {	27,000	L6
R6	V1 osc. C.G. ...	47,000	M6
R7	Osc. stabilizer ...	180	M5
R8	Osc. H.T. feed ...	22,000	L6
R9	Osc. coupling ...	5,600	L6
R10	V2 S.G. feed ...	100,000	L5
R11	I.F. stopper ...	47,000	J6
R12	A.G.C. decoupling ...	680,000	J5
R13	Volume control ...	500,000	K4
R14	F.-B. coupling {	1,000	K4
R15	resistors ...	100,000	H5
R16	V3 C.G. resistor ...	1,000,000	H4
R17	V3 C.G. decoup. ...	470,000	J5
R18	V3 triode load ...	220,000	J5
R19	A.G.C. diode load ...	680,000	J5
R20	V1-V4 G.B.; A.G.C. {	47	J5
R21	delay resistors ...	82	J5
R22	A.F. stabilizer ...	47	J5
R23	V4 C.G. resistor ...	470,000	H5
R24	V4 C.G. stopper ...	100,000	H5
R25	F.-B. series resist- {	150,000	K4
R26	ors ...	2,700	H4
R27	F.-B. potential {	4,700	H4
R28	divider resistors {	220	J4
R29	H.T. smoothing ...	1,500	K5

CAPACITORS		Values (μF)	Locations
C1	I.F. rejector tune ...	0.00056	M5
C2	Aerial coupling ... {	0.0015	M4
C3	capacitors ... {	0.0033	L4
C4	V1 hex C.G. ...	0.0001	B2
C5	V1 S.G. decoup. ...	0.047	M6
C6	1st I.F. trans. {	0.00015	B3
C7	tuning ... {	0.00015	B3
C8	V1 osc. C.G. ...	0.00015	L5
C9	H.T. R.F. by-pass ...	0.1	H4
C10	Osc. M.W. tracker ...	0.00036	L5
C11	Osc. L.W. trimmer ...	0.00001	L4
C12	Osc. L.W. tracker ...	0.00015	M5
C13	Osc. anode coup. ...	0.0001	M5
C14	A.G.C. decoupling ...	0.1	J5
C15	V2 S.G. decoupling ...	0.047	K5
C16	2nd I.F. trans. {	0.00015	B3
C17	tuning ... {	0.00015	D3
C18	I.F. by-pass ...	0.0001	K6
C19	A.G.C. coupling ...	0.000047	J6
C20	A.F. coupling ...	0.01	J4
C21	F.-B. coupling ... {	0.000033	H4
C22	capacitors ... {	0.00015	H5
C23	V4 G.B. decoupling ...	0.1	H5
C24	A.F. coupling ...	0.0047	J5
C25	G.B. by-pass ...	25.0	H6
C26	Tone corrector ...	0.001	D1
C27	F.-B. coupling ... {	0.1	J4
C28	capacitors ... {	0.12	J4
C29	capacitors ... {	0.047	J4
C30	H.T. smoothing ...	32.0	C2
C31	capacitors ...	32.0	C2
C32	Aerial M.W. trim. ...	0.000012	M4
C33	Aerial L.W. trim. ...	0.000032	M4
C34	Aerial tuning ...	—	B1
C35	Oscillator tuning ...	—	B2
C36	Osc. S.W. trim ...	0.00003	L5
C37	Osc. M.W. trim ...	0.00003	L5
C38	Osc. L.W. trim ...	0.000032	L4

* Electrolytic. † Variable. ‡ Pre-set.

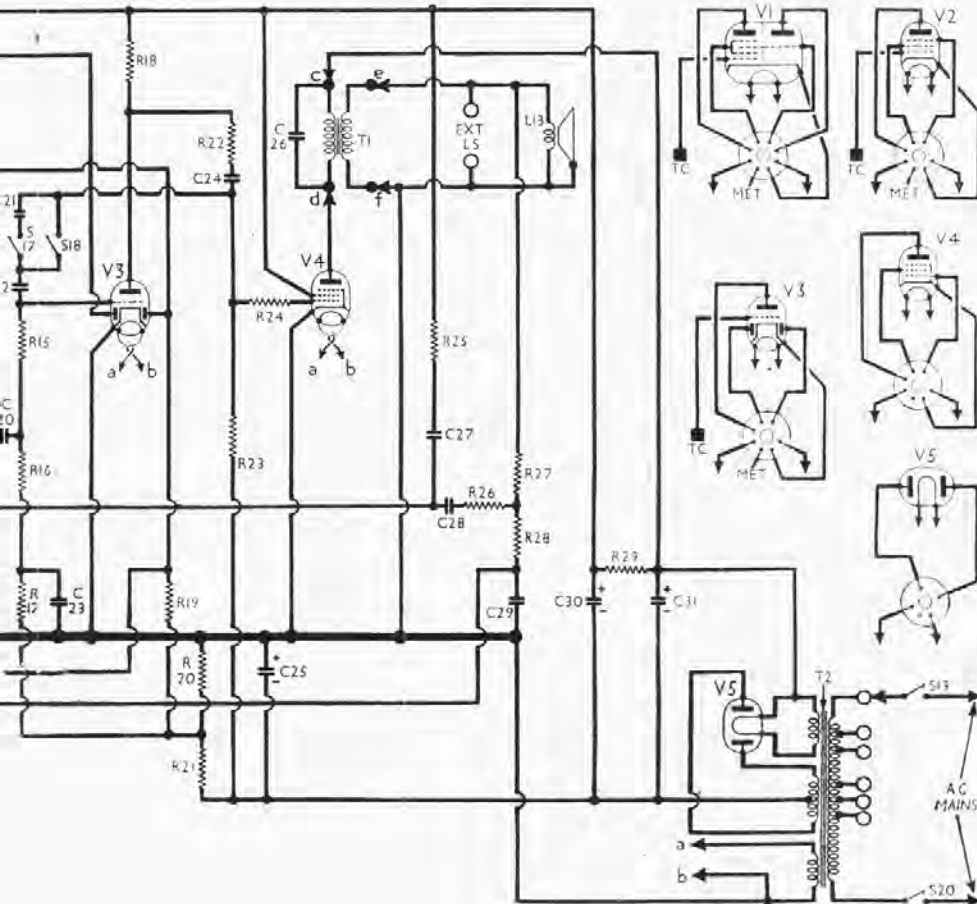

OTHER COMPONENTS		Approx. Values (ohms)	Locations
L1	I.F. rejector coil ...	4.0	M5
L2	S.W. R.F. choke ...	Very low	L4
L3	Aerial tuning coils {	7.5	A1
L4	... {	24.0	A1
L5	Oscillator tuning {	Very low	L5
L6	coils ... {	8.0	A2
L7	Osc. S.W. react. ...	12.0	A2
L8	1st I.F. trans. { Pri. ...	0.1	L5
L9	Sec. ...	8.0	B3
L10	2nd I.F. trans. { Pri. ...	8.0	B3
L11	Sec. ...	8.0	D3
L12	Speech coil ...	8.0	D3
L13	Output trans. { Pri. ...	2.75	—
T1	trans. { Pri. ...	380.0	C1
	Sec. ...	0.5	C1
	Heat. sec. ...	51.0	F1
T2	Mains trans. { Pri. ...	0.1	F1
	Rec. heat. sec. ...	0.2	F1
	H.T. sec. total ...	1,100.0	F1
S1	W/band switches ...	—	L5
S13	Plate aerial switch ...	—	M6
S14	Radio/Gram switches ...	—	J6
S15	Tone control switches ...	—	H4
S16	Mains sw., g'd R13 ...	—	K4
S17			
S18			
S19			
S20			

VALVE ANALYSIS

Valve voltages and currents given in the table below are those measured in our receiver when it was operating on mains

Valve	Anode Voltage (V)	Anode Current (mA)	Screen Voltage (V)	Screen Current (mA)
V1 ECH35	237	2.5	94	2.0
V2 EF39	102	5.4	84	1.4
V3 EBC33	237	4.3	—	—
V4 EL33	75	0.6	—	—
V5 AZ31	257	35.0	237	3.6
	292†	—	—	—

† Each anode, A.C.

of 224 V, using the 220 V tapping on the mains transformer.

The receiver was tuned to the lowest wavelength on the M.W. band, and the volume control was at maximum, but there was no signal input. Voltages were measured on the 400 V scale of a model 7 Avometer, chassis being the negative connection.

DISMANTLING THE SET

Almost unimpeded access to the top and underside of the chassis may be gained upon removal of the back cover (two round-head wood screws and two cheese-head screws, with washers) and bottom cover (four cheese-head screws, with washers).

Removing Chassis.—Remove back cover as previously described;

remove the two front control knobs (recessed grub screws), and from the rear of the cabinet remove the two side control knobs (one cheese-head screw each, accessible through cut-away sections of the rear chassis member);

from the underside of the cabinet remove the bottom fixing screw (with washer) to which a flexible earthing lead is attached;

if the two large chassis fixing screws (with lock-washers), located to the left of the gang and adjacent to the mains transformer, are now removed, the chassis may be slid from the cabinet to the extent of the speaker leads, which is sufficient for most purposes.

To free the chassis entirely unsolder the speaker leads at tags on the output transformer.

When replacing, the waveband and tone control switches should be turned fully anti-clockwise before inserting the chassis in the cabinet.

Do not omit to replace the yellow plate aerial connecting lead beneath the head of the left-hand chassis fixing screw, and the black base screen lead beneath the appropriate bottom cover fixing screw.

Removing Speaker.—Remove the three nuts (with washers) securing the speaker to the sub-baffle, and lift it out.

Switch Tables and Diagram

Switch	S.W.	M.W.	L.W.
S1	C	C	—
S2	C	—	—
S3	C	C	—
S4	—	—	C
S5	—	C	C
S6	C	—	—
S7	—	C	—
S8	—	—	C
S9	—	—	C
S10	C	—	C
S11	—	C	—
S12	C	—	—
S13	C	—	—

GENERAL NOTES

S1-S13 are the waveband switches, ganged in a single rotary unit beneath the chassis. The unit is indicated in our under-chassis view, and shown in detail in the diagram in col. 2, where it is viewed as seen from the control knob with the chassis inverted, as indicated by the arrow in our photograph.

The table (col. 2) gives the switch positions for the three control settings, starting from the fully anti-clockwise position of the control knob. A dash indicates open, and C, closed.

S14 is the plate aerial shorting switch. It is operated by insertion or removal of the external aerial plug, and connects the plate aerial to chassis when an external aerial is in use.

S15, S16 are the radio/gram change-over switches, in a two-position unit mounted on the rear chassis member. The tags are clearly identified in our under-chassis illustration. On radio (control lever down) S15 is closed, and S16 open. On gram (control lever up) the position is reversed.

S17, S18 are the tone control switches, in a three-position rotary unit beneath the chassis. Its position is indicated in our under-chassis view, where an arrow shows the direction in which it is viewed in the diagram in col. 2. In the normal position (knob fully clockwise) both switches are open; in the middle position (reduced high-note response) S17 closes; in the anti-clockwise position ("deep" tone) S17 is open, and S18 closed.

S19, S20 are the QMB mains switches in a circular unit mounted concentrically round the volume control spindle, and operated by a lever mounted on the spindle.

Coils.—The I.F. rejector coil L1 and the aperiodic S.W. aerial coil L2 are in two unscreened units beneath the chassis. The M.W. and L.W. aerial tuning coils L3, L4 and oscillator tuning coils L6, L7 are in two screened units on the chassis deck. In each case the L.W. coil core is adjusted from the upper end of the unit, and the M.W. core from beneath the chassis. Diagrams in col. 4 show the base connections of these two units. The S.W.

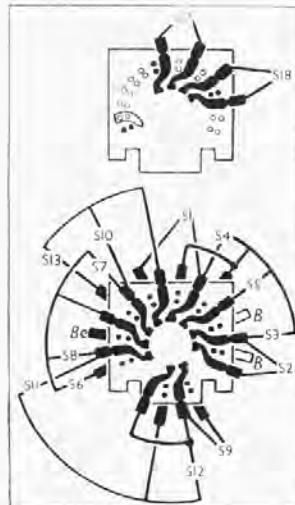

Diagrams of the tone control (top) and waveband (bottom) switch units, viewed in the direction of the arrows in our under-chassis view. The table above the diagrams gives the switch positions for the three settings of the lower (waveband) unit.

When replacing, the connecting panel should point to the left-hand side of the cabinet, and the leads should be resoldered to the rear tags (e, f) on the output transformer.

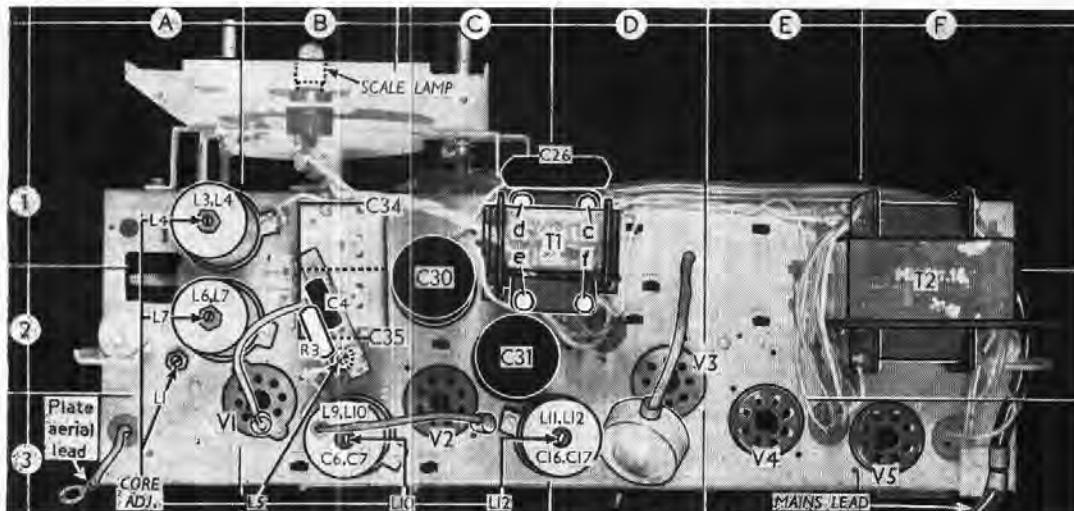

Plan view of the chassis, showing the aerial, oscillator and I.F. secondary core adjustments. The connections of the output transformer T1 are lettered c, d, e, f to agree with those in the circuit diagram.

Under-chassis view. The tags of the radio/gram switch unit **S15**, **S16**, are identified here. Diagrams of the waveband switch unit **S1-S13** and the tone control unit **S17**, **S18** appear in col. 2. **S14** is associated with the aerial socket.

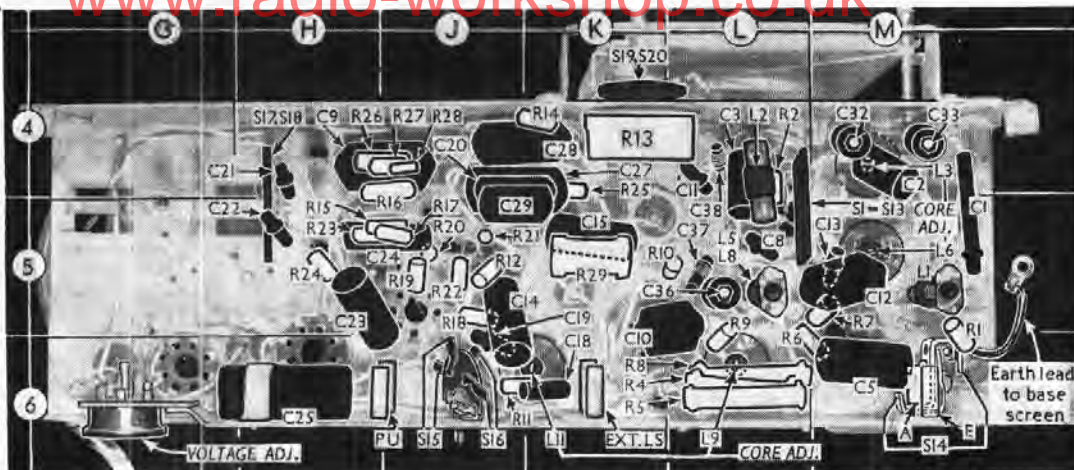

oscillator coils **L5**, **L8** form a third un-screened unit beneath the chassis.

Scale Lamp.—This is mounted in a plastic bayonet-fitting holder on the scale assembly. The lamp is a Philips type 8045/D00, rated at 6 V, 0.32 A. It has a tubular bulb and an M.E.S. base.

External Speaker.—Two sockets are provided at the rear of the chassis for the connection of a low-impedance (5-7 Ω) external speaker.

Chassis Divergencies.—In a few early versions, **L2** may not be fitted, and the

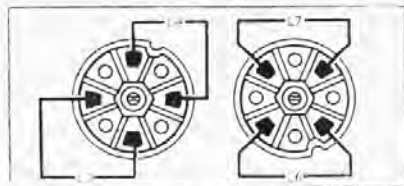

Diagrams showing the base connections of the two M.W. and L.W. coil units.

waveband switch unit may be arranged to short-circuit **R2**, **C3** on the S.W. band. In some chassis, too, the positions of **C32** and **C37** may be transposed.

CIRCUIT ALIGNMENT

These operations may be carried out with the chassis in the cabinet, after removal of the bottom cover.

I.F. Stages.—Switch set to M.W., tune to 375 m on scale, turn volume control to maximum, and connect signal generator, via an 0.047 μF capacitor in the "live" lead, to control grid (top cap) of **V1** and chassis. Shunt **L11** (location reference **K6**) with an 0.0001 μF capacitor, feed in a 470 kc/s (638.3 m) signal, and adjust the core of **L12** (**D3**) for maximum output. Transfer shunting capacitor to **L10** (**L6**) and adjust the cores of **L11** (**K6**) and **L9** (**L6**) for maximum output. Finally, transfer shunting capacitor to **L9** (**L6**) and adjust the core of **L10** (**B3**) for maximum output, and then disconnect "live" signal generator lead and shunting capacitor.

I.F. Rejector.—With set still switched to M.W., tune to 560 m on scale, transfer "live" signal generator lead to **A** socket, via a suitable dummy aerial, feed in a strong 470 kc/s signal, and adjust the core of **L1** (**A2**) for minimum output.

R.F. and Oscillator Stages.—With the gang at minimum capacitance the pointer should be horizontal. It may be adjusted in position by rotating it on its spindle. Note that the local oscillator frequency in this receiver is higher than the signal frequency on all bands.

When adjusting a wire-wound trimmer, wire should be unwound until output, having reached a maximum, begins to decrease. The winding should then be sealed with wax and any surplus cut off. Do not attempt to increase capacitance by adding wire, as the turns would not remain in place, but replace capacitor with a new one.

M.W.—With set still switched to M.W., tune to 500 m on scale, feed in a 500 m (600 kc/s) signal, and adjust the core of **L6** (**M5**) for maximum output. Tune to 200 m (line on scale), feed in a 200 m (1,500 kc/s) signal, and adjust **C37** (**L5**) for maximum output. Retune to 500 m on scale, feed in a 500 m signal, and adjust core of **L3** (**M4**) for maximum output. Retune to the 200 m calibration line, feed in a 200 m signal, and adjust **C32** (**M4**) for maximum output. Repeat these operations until no improvement results.

L.W.—Switch set to L.W., tune to 1,720 m (line on scale), feed in a 1,720 m (174.4 kc/s) signal, and adjust the core of **L7** (**A2**) for maximum output. Tune to 790 m (line on scale), feed in a 790 m (379.8 kc/s) signal, and adjust **C38** (**L4**) for maximum output. Retune to 1,720 m on scale, feed in a 1,720 m signal, and adjust the core of **L4** (**A1**) for maximum output. Retune to 790 m on scale, feed in a 790 m signal, and adjust **C33** (**M4**) for maximum output. Repeat these operations until no improvement results.

S.W.—Switch set to S.W., tune to 50 m on scale, feed in a 50 m (6 Mc/s) signal, and adjust the core of **L5** (**B2**) for maximum output. Turn gang to minimum capacitance, feed in a 16.22 m (18.5 Mc/s) signal, and adjust **C36** (**L5**) for maximum output.

DRIVE CORD REPLACEMENT

For replacement of the tuning drive cord, the scale assembly must be removed. This entails simply removing the scale lamp holder, withdrawing the scale pointer (push-on fit) and removing the two fixing screws (with flat washers and lock-washers) holding the assembly to the chassis.

Make up the cord, with a loop at each end, so that the overall length is 446 mm (ours measured 17½ inches). Turn the gang to maximum, when the drum should be in the position shown in our sketch below, hook one end of the cord to one end of the tension spring, which in turn is hooked to its anchor, and run the cord over the guide pin and down to the control spindle.

Make 2½ turns clockwise round the spindle and complete the run as shown in the sketch. Keep the cord well to the front of the waisted portion of the control spindle, as if it gets close to the chassis it tends to run off the flat rim of the drum. When refitting the pointer, hold it near the middle, where it is strong.

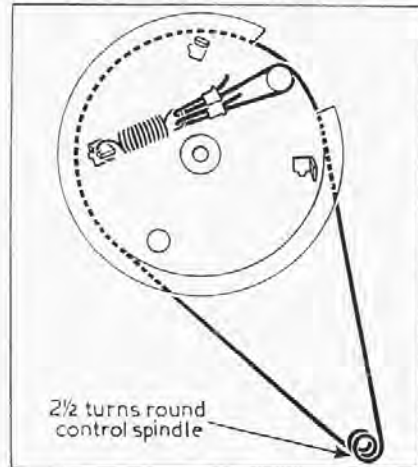

Sketch of the tuning drive cord, drawn as seen from the front of the chassis, after removing the scale assembly, with the gang at maximum.