

RAYMOND F19

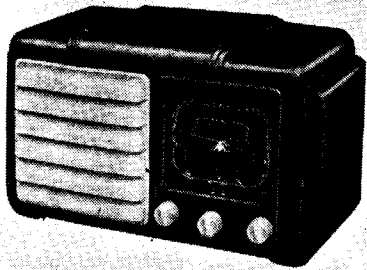

Five-valve three-waveband superhet for operation on 200 to 250 volt AC or DC mains. Moulded plastic cabinet. Manufactured by Raymond Electric Ltd., 26, Wandsworth Road, Perivale, Middlesex.

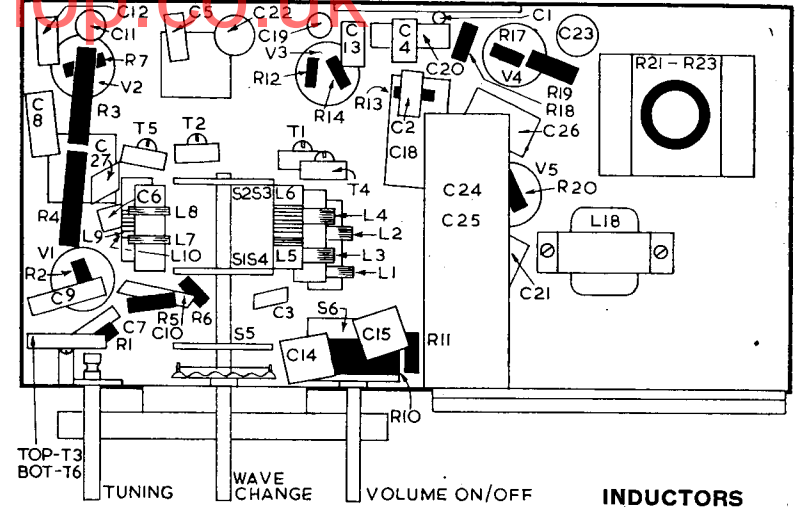
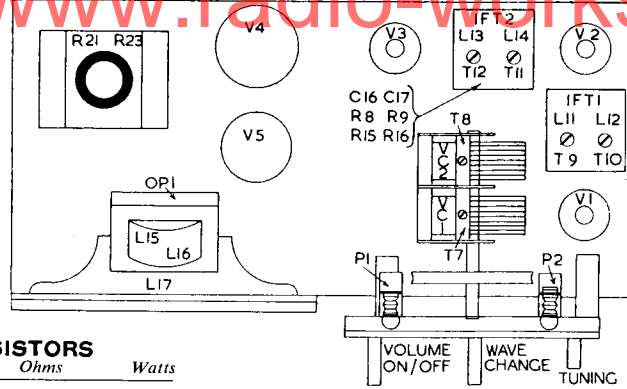

RESISTORS

R	Ohms	Watts	R	Ohms	Watts	R	Ohms	Watts
1	270	1/4W	10	500k	Potentiometer with Switch	16	1.2m	1/4W
2	47k	1/4W	11	1.2m	1/4W	17	330k	1/4W
3	68k	1/4W	12	3.3k	1/4W	18	22k	1/4W
4	33k	1/4W	13	100k	1/4W	19	180	1/4W
5	4.7k	1/4W	14	100k	1/4W	20	68	1/4W
6	300	1/4W	15	1.2m	1/4W	21	750	1/4W
7	330	1/4W				22	100	1/4W
8	100k	1/4W				23	100	1/4W
9	330k	1/4W						

Tapped vitreous Resistor 10W

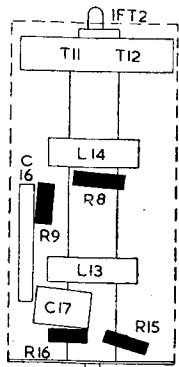

FRONT CHASSIS WAFER

MIDDLE WAFER

REAR CHASSIS WAFER

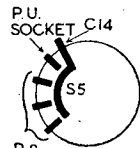

PU SOCKET C14

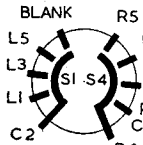

BLANK

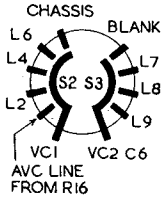

CHASSIS

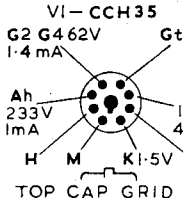

V1 - 6X4

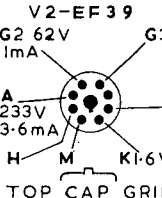

V2 - 6X4

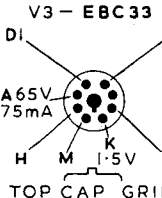

V3 - 6X4

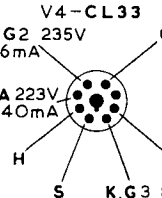

V4 - 6X4

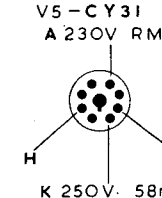

V5 - 6X4



DIAL LAMP

CAPACITORS

C	Capacity	Type
1	Formed in Wiring with Systoflex sleeving	
2	.01 Mica	
3	200pF Silver Mica	
4	.01 Mica	
5	.01 Mica	
6	47pF Silver Mica	
7	.01 Tubular 350V	
8	.05 Tubular 500V	
9	.004 Mica	
10	200pF Silver Mica	
11	.05 Tubular 500V	
12	.01 Mica	
13	.01 Mica	
14	.01 Mica	
15	.01 Mica	
16	200pF Silver Mica	
17	47pF Silver Mica	
18	.25 Tubular 350V	
19	.005 Tubular 500V	
20	.05 Tubular 500V	
21	.01 Mica	
22	25 Electrolytic 25V	
23	25 Electrolytic 25V	
24	16 Electrolytic 450V	
25	8 Electrolytic 450V	
26	.01 Mica	
27	47pF Silver Mica	

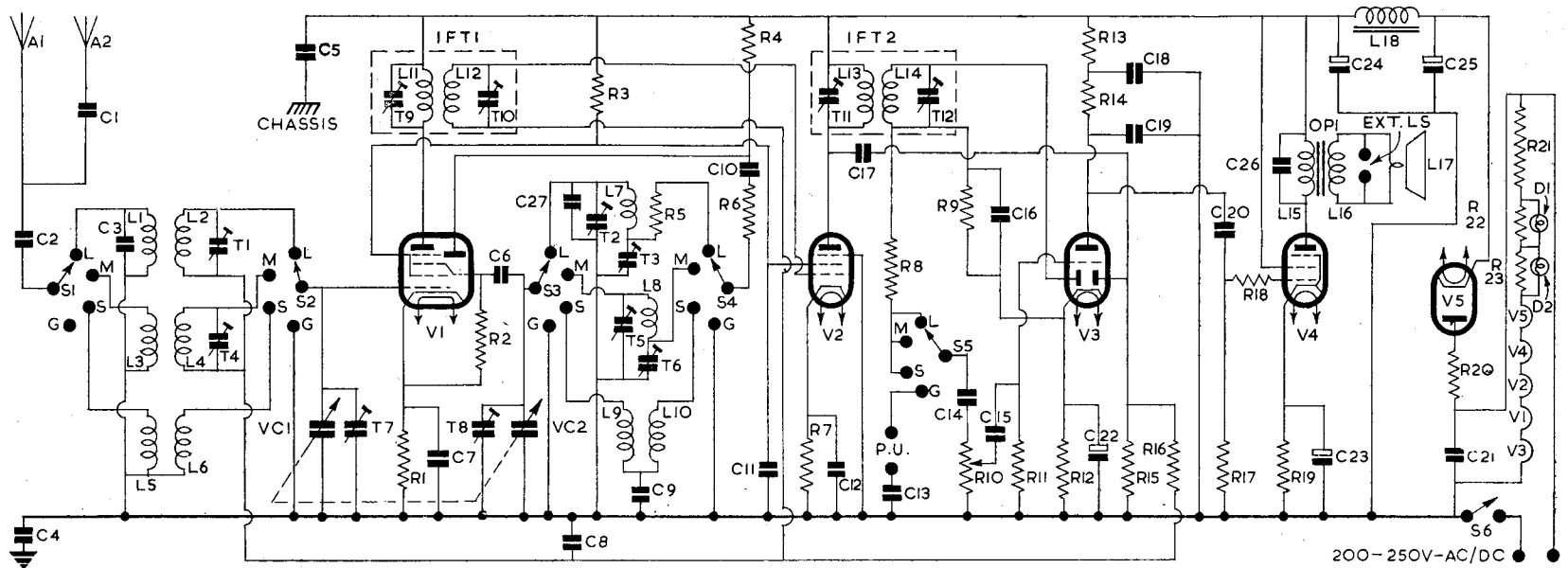

RAYMOND F19

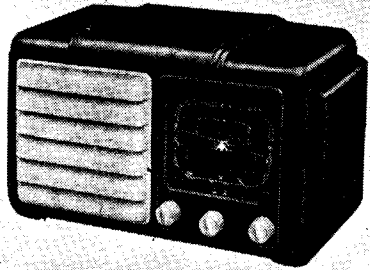

Five-valve three-waveband superhet for operation on 200 to 250 volt AC or DC mains. Moulded plastic cabinet. Manufactured by Raymond Electric Ltd., 26, Wandsworth Road, Perivale, Middlesex.

www.radio-workshop.co.uk

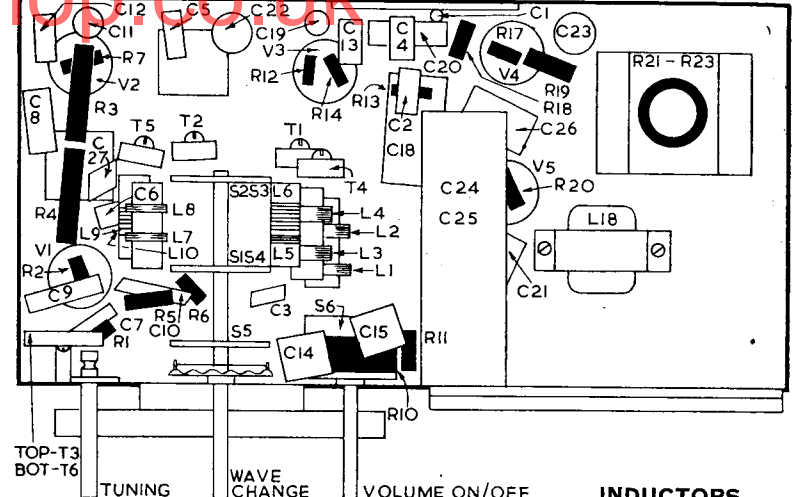
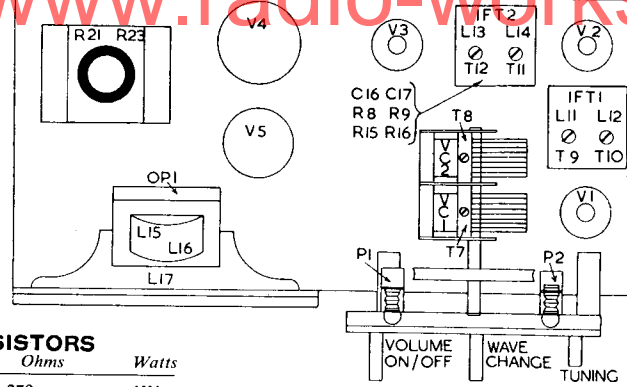

RESISTORS

R	Ohms	Watts	R	Ohms	Watts	R	Ohms	Watts
1	270	1/4W	10	500k	Potentiometer with Switch	16	1.2m	1/4W
2	47k	1/4W	11	1.2m	1/4W	17	330k	1/4W
3	68k	1W	12	11	1/4W	18	22k	1/4W
4	33k	1W	13	3.3k	1/4W	19	22k	1/4W
5	4.7k	1/4W	14	100k	1/4W	20	180	1/4W
6	300	1/4W	15	100k	1/4W	21	68	1/4W
7	330	1/4W	16	100k	1/4W	22	750	1/4W
8	100k	1/4W	17	100k	1/4W	23	100	1/4W
9	330k	1/4W	18	100k	1/4W	24	100	1/4W

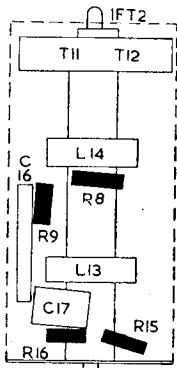

FRONT CHASSIS WAFER

MIDDLE WAFER

REAR CHASSIS WAFER

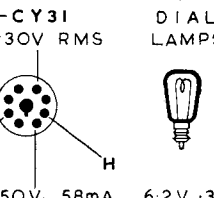
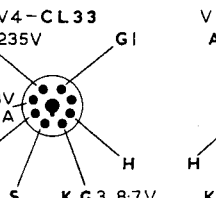
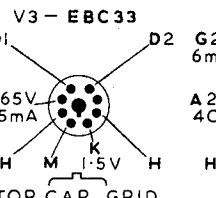
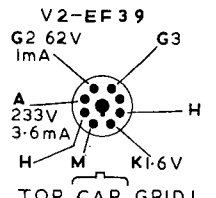
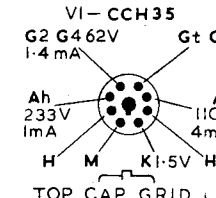
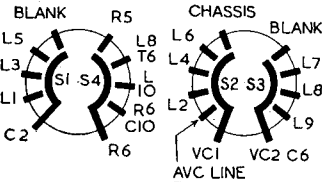

CAPACITORS

C	Capacity	Type
1	Formed in Wiring with Systoflex sleeving	
2	.01 Mica	
3	200pF Silver Mica	
4	.01 Mica	
5	.01 Mica	
6	.01 Mica	
7	47pF Silver Mica	
8	.01 Tubular 350V	
9	.05 Tubular 500V	
10	.004 Mica	
11	200pF Silver Mica	
12	.05 Tubular 500V	
13	.01 Mica	
14	.01 Mica	
15	.01 Mica	
16	200pF Silver Mica	
17	47pF Silver Mica	
18	.25 Tubular 350V	
19	.005 Tubular 500V	
20	.05 Tubular 500V	
21	.01 Mica	
22	25 Electrolytic 25V	
23	25 Electrolytic 25V	
24	16 Electrolytic 450V	
25	8 Electrolytic 450V	
26	.01 Mica	
27	47pF Silver Mica	

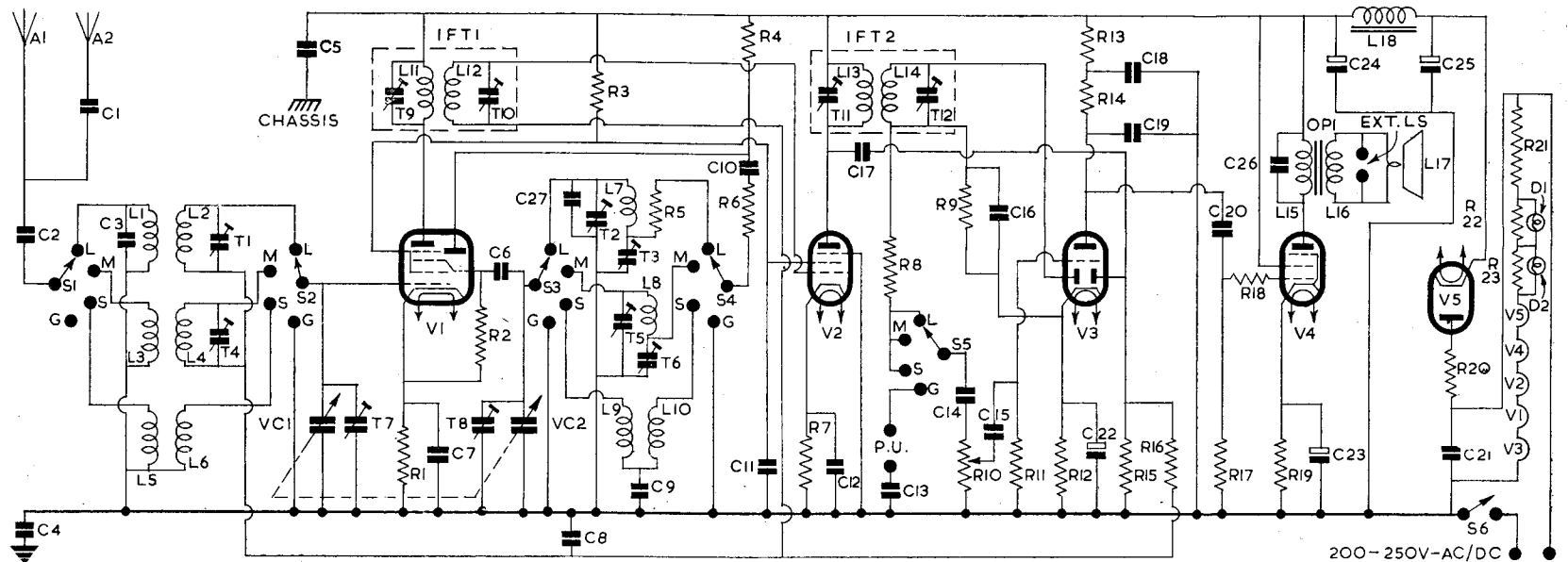

200-250V-AC/DC

RAYMOND F19—Continued

CIRCUIT consists of a triode-hexode frequency-changer V1 coupled by a capacity-tuned transformer to the variable-mu IF amplifier V2. A second capacity-tuned transformer couples V2 to diode signal rectifier section of V3. The other diode is used for AVC. After rectification the signal is amplified by triode section of V3 and fed to grid of output pentode valve V4. The output is then fed into a 6½-in. PM loudspeaker. On AC mains supplies an indirectly-heated half-wave rectifier V5 provides the HT supply.

Aerial. Two sockets are provided. The A1 socket connects aerial through isolating capacitor C2 to switch S1. The A2 socket provides attenuation of the received signal by including a small capacity (formed by wire and Systoflex sleeving) in series with lead to C2.

S1 switches aerial to coupling coils L1 (LW) 13 (MW) and L5 (SW). C3 is shunt capacitor across LW coupling coil. L2 (LW), L4 (MW), L6 (SW), the grid coils, are switched by S2 to aerial tuning capacitor VC1 and to g1 of V1. T1 (LW), T4 (MW) and T7 (SW) are trimmers.

AVC is applied to g1 on LW and MW bands, through L2 and L4, and is decoupled by capacitor C8. When S2 is in the gram position g1 of V1 is connected down to chassis. Cathode bias is provided by R1 and decoupled by C7. Screen g2, g4 voltage is obtained from R3 decoupled by C11. L11, T9, the primary of IFT1, is in the hexode anode circuit of V1.

Oscillator is connected in a tuned-grid parallel-fed HT circuit. L7 (LW), L8 (MW), L9 (SW), the grid coils, are switched by S3 to oscillator tuning capacitor VC2, and through coupling capacitor C6 to tg of V1. T2, C27 (LW), T5 (MW), T8 (SW) are trimmers and T3, T6, C9 padders.

R2 is oscillator grid leak; bias for grid is developed on C6. When S3 is in the gram position tg is connected down to chassis.

Anode reaction voltages on LW and MW bands are developed on the padders T3 and T6. On SW band, however, it is obtained from L10. R5 is LW limiter resistor. S4 switches feedback voltages through series limiter R6 and coupling capacitor C10 to oscillator anode of V1. R4 is oscillator anode load.

IF amplifier operates at 465 kc/s. L12, T10, the secondary of IFT1, feeds signal and AVC voltages to g1 of IF amplifier valve V2. C8 is AVC decoupling capacitor. Cathode bias is provided by R7 decoupled by C12. Screen g2 voltage is obtained from R3 and decoupled by C11. Suppressor g3 is connected down to chassis. L13, T11, the primary of IFT2, is in the anode circuit of V2.

Signal rectifier. L14, T12, the secondary of IFT2, feeds signal to one of diodes of V3. R9 is diode load resistor and C16 filter capacitor. Signal developed on diode load is fed through R8 to L, M and S contacts on S5 and thence via C14 to volume control R10.

Pickup sockets are provided for connection of magnetic or crystal type pickup. Signal from PU is fed to S5 and thence through C14 to volume control R10. Earth socket of pickup is connected through isolating capacitor C13 to chassis.

Automatic volume control. C17 feeds signal at anode of V2 to second diode of V3. R15 is load resistor, R16 feed resistor, and C8 decoupling capacitor. Delay voltage is provided by the cathode bias developed on R12.

AF amplifier. C15 feeds signal from volume control R10 to grid of triode section of V3. R11 is its grid resistor. R14 is the anode load resistor and C19 anode RF bypass capacitor. R13, with C18, provides decoupling of HT supply to anode V3.

Output stage. C20 feeds signal from anode V3 to g1 of pentode output valve V4. R17 is grid resistor and R18 grid stopper. Cathode bias is provided by R19 decoupled by C23. Screen G2 voltage is obtained direct from HT line of receiver. Suppressor g3 is internally connected to cathode. L15, the primary of OP1, the output matching transformer, is in the anode circuit of V4. C26 prevents rise in impedance of L15 at higher frequencies. L16, the secondary of OP1, feeds signal to a 6½-in. PM loudspeaker L17. Sockets are fitted on L16 to allow connection of a low impedance type extension speaker.

High tension. On AC mains supplies HT is obtained from an indirectly heated half-wave rectifier V5. Its anode voltage is obtained from the mains supply through limiter resistor R20. L18, C24, C25 provide choke-capacity smoothing of the HT supply. C21 eliminates any modulation hum and C5 is RF bypass capacitor.

Removal of chassis. Remove the three control knobs and rear panel of cabinet. Remove the four chassis bolts on underside of cabinet. The heads of these bolts are covered with an insulating compound which should be renewed after chassis bolts are replaced.

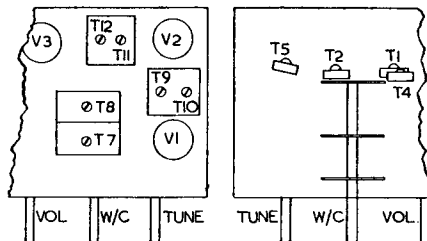

TRIMMING INSTRUCTIONS

Apply signal as stated below	Tune receiver to	Trim in order stated for max. output
1) 465 kc/s to G1 of V2 (with grid lead removed)	550 metres	T12, T11
2) 465 kc/s to G1 of V1 (with grid lead removed)	—	T10, T9 and check setting of T11, T12 and adjust if necessary
3) Check that pointer on denser at minimum	scale is set at capacity	zero with gang capacity
4) 15 mc/s to Ae socket via dummy aerial	20 metres	T8, T7
5) 6 mc/s as above ..	50 metres	Check calibration on scale.
6) 1.4 mc/s as above ..	215 metres	T5, T4
7) 600 kc/s as above ..	500 metres	T6, Repeat (6) and (7)
8) 300 kc/s as above ..	1,000 metres	T2, T1
9) 165 kc/s as above ..	1,800 metres (approx.)	T3, Repeat (8) and (9)

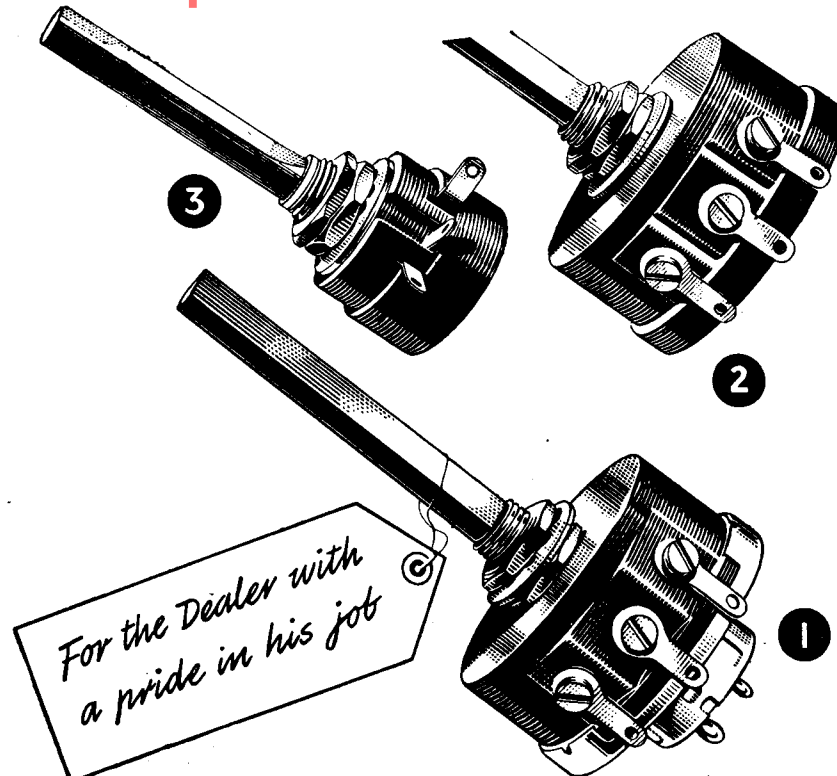

RADIOSPARES WIRE-WOUND VOLUME CONTROLS

Fitted with SPST switch, 3 watt type, fitted ¼" flat spindle of 2" free length—illustrated (1) above. Available in following values: 250Ω 500Ω 1,000Ω 2,500Ω 5,000Ω 10,000Ω 15,000Ω 20,000Ω 25,000Ω 35,000Ω 50,000Ω. All at a nett trade price of 4/6 each.

Identical control, less switch, 3 watt type, fitted ¼" flat spindle of 2" free length—illustrated (2) above (one-quarter enlarged). Available in following values:— 1,000Ω 2,500Ω 5,000Ω 10,000Ω 15,000Ω 20,000Ω 25,000Ω 35,000Ω 50,000Ω. All at a nett trade price of 3/9 each.

RADIOSPARES EXTENSION LOUDSPEAKER VOLUME CONTROLS

Wire-wound, fitted ½" flat spindles of 1½" free length—illustrated (3) above.

Available in the following values: 25Ω 50Ω

All at a nett trade price of 3/6 each.

These goods are available as and when listed in our current bulletin only. All these guaranteed quality components are obtainable only direct from

Radiospares Ltd.

19-23 FITZROY STREET, LONDON, W.1
Telegrams: Radospares, Wesdo, London.

Telephone: MUSeum 9301/6
Cables: Radospares, London