

RAYMOND F42

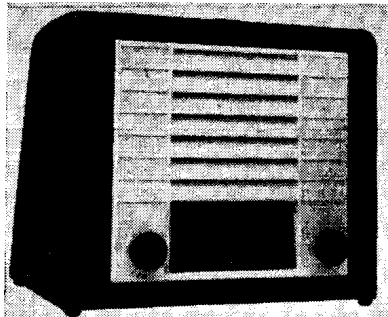

Four-valve, three-waveband superhet with sockets for aerial, earth, high-resistance pickup, and low-impedance extension loud-speaker. Brown-cream moulded cabinet. Suitable for 100-110, 200-250V, 50c/s mains. Made by Raymond Electric, Ltd., Brent Crescent, North Circular Road, London, NW10.

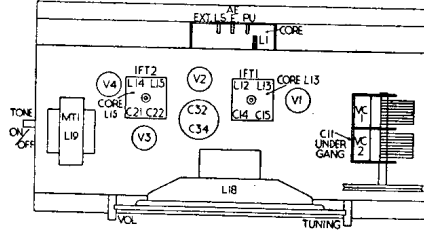

AERIAL signal is fed through isolating capacitor C1 to IF filter L1, C2, and switched by S1 to coupling coils L2 (LW), L3 (MW), L4 (SW). The inductively coupled grid coils L5 (LW), L6 (MW) are switched by S2, through L7 (SW) to aerial tuning capacitor VC1, and coupled by C5 to g1 of triode-hexode frequency changer V1. T1 (LW), T2 (MW), T3, C3 (SW) are trimmers and C4 gives capacitive coupling between L4, L7 on SW.

Cathode of V1 is connected to earth line. A small standing bias and AVC decoupled by C7 are applied through R1 to g1 of V1. Screen (g2, g4) voltage is obtained from potential divider R2, R3 and is decoupled by C8.

Oscillator is connected in a tuned anode shunt

Continued opposite

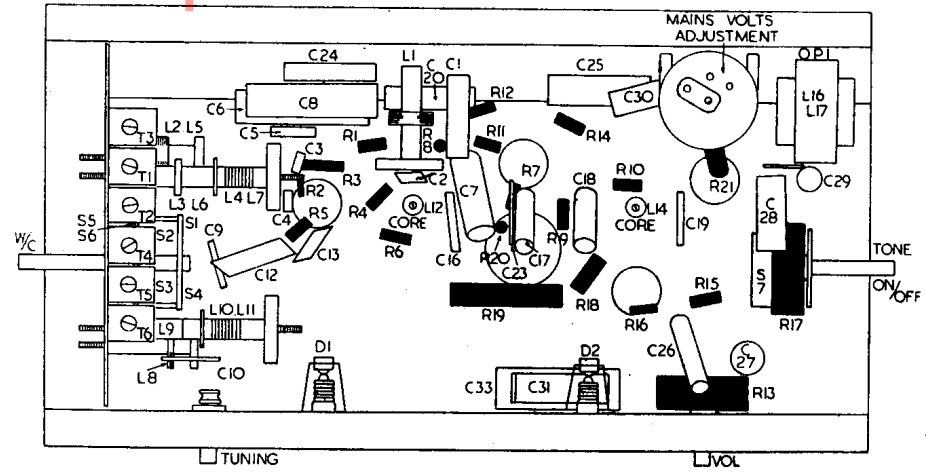

| | | | | | | | | | | | | |
|---|-------|-----------|----|----|----|----|----|----|----|----|----|----|
| R | 25 | 1,3 | 6 | 8 | 11 | 7 | 9 | 10 | 15 | 21 | 17 | |
| C | 9,6 | 8,3,5,24 | 2 | 20 | 1 | 17 | 18 | 25 | 30 | 19 | 28 | 29 |
| L | 9,2,5 | 10,11,4,7 | 12 | 13 | 1 | 12 | 13 | 1 | 14 | 15 | 16 | 17 |

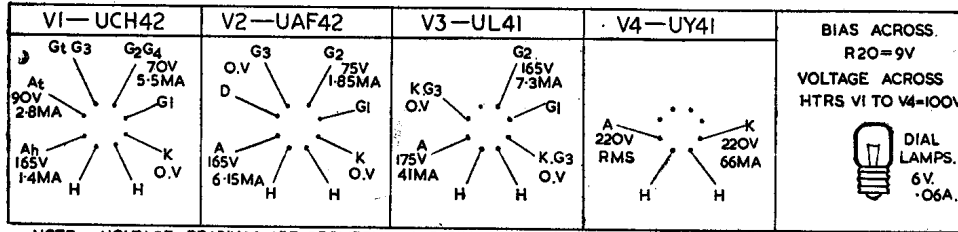

NOTE.— VOLTAGE READINGS ARE BETWEEN VALVE PINS AND EARTH WIRING (NOT CHASSIS.)

CAPACITORS

| C | Capacity | Type |
|----|--------------|---------------|
| 1 | .005 Tubular | 500V |
| 2 | 47pF | Silver Mica |
| 3 | 3.5pF | Ceramic |
| 4 | 3.5pF | Ceramic |
| 5 | 1000pF | Silver Mica |
| 6 | .25 | Tubular 1000V |
| 7 | .02 | Tubular 350V |
| 8 | .1 | Tubular 500V |
| 9 | 150pF | Silver Mica |
| 10 | 490pF | Silver Mica |

RESISTORS

| R | Ohms | Watts |
|----|------|------------------------|
| 1 | 1.2M | ... |
| 2 | 27K | ... |
| 3 | 18K | ... |
| 4 | 22K | ... |
| 5 | 100 | ... |
| 6 | 47K | ... |
| 7 | 47K | ... |
| 8 | 1.2M | ... |
| 9 | 22M | ... |
| 10 | 2.7M | ... |
| 11 | 1.5M | ... |
| 12 | 10M | ... |
| 13 | 500K | Potr. |
| 14 | 47K | ... |
| 15 | 820K | ... |
| 16 | 100K | ... |
| 17 | 50K | Potr. with DPST Switch |
| 18 | 1.8K | ... |
| 19 | 450 | ... |
| 20 | 150 | ... |
| 21 | 145 | ... |

INDUCTORS

| L | Ohms |
|----|------|
| 1 | ... |
| 2 | ... |
| 3 | ... |
| 4 | ... |
| 5 | ... |
| 6 | ... |
| 7 | ... |
| 8 | ... |
| 9 | ... |
| 10 | ... |
| 11 | ... |
| 12 | ... |
| 13 | ... |
| 14 | ... |
| 15 | ... |
| 16 | ... |
| 17 | ... |
| 18 | ... |
| 19 | ... |

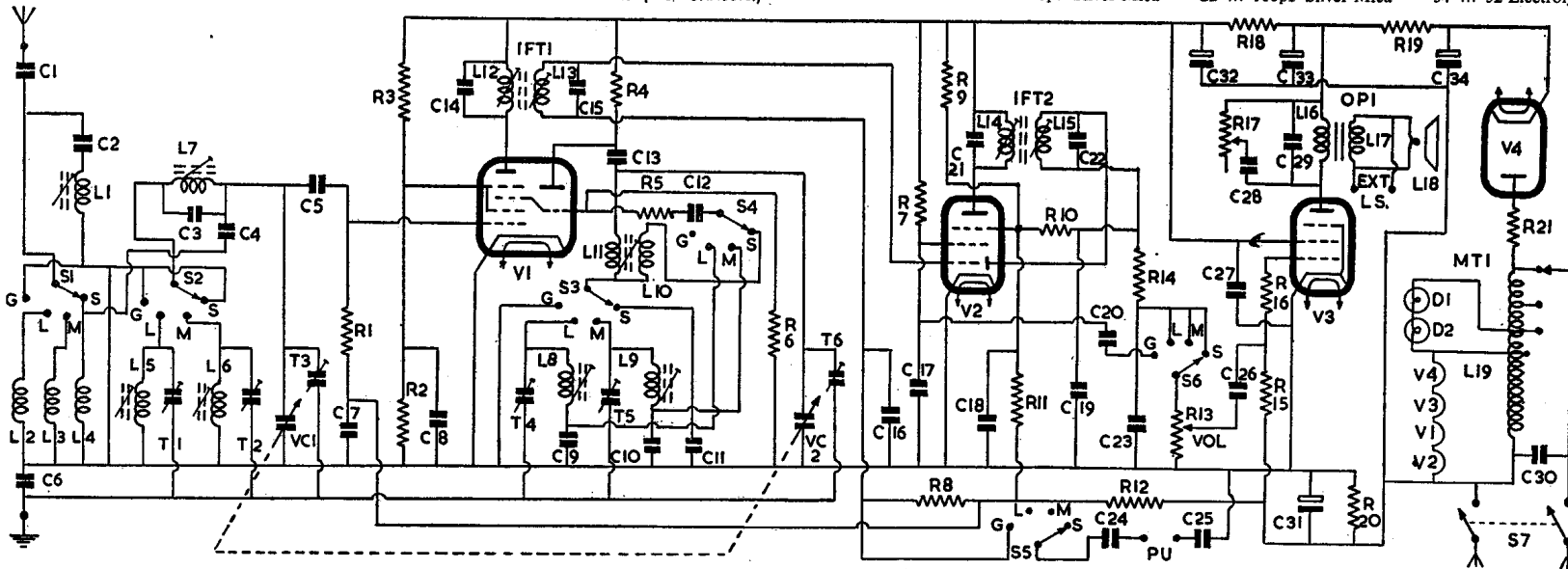

RAYMOND F42

fed circuit. The anode coils L8 (LW), L9 (MW) which are trimmed by T4, T5 respectively, are switched by S3 through L11 (SW) to oscillator tuning capacitor VC2 and coupled by C13 to oscillator anode of V1, of which R4 is the load resistor. T6 is SW trimmer and C9 (LW), C10 (MW) C11 (SW) are padders. Grid reaction voltages are developed inductively by L10 (SW) and capacitively from C10 (MW), C9 (LW) and are switched by S4 through C12 and limiter resistor R5 to oscillator grid of V1. Self bias for grid is developed on C12 with R6 as leak resistor.

It should be noted that earth side of aerial and oscillator trimmers are connected direct to chassis and that chassis is coupled to earth-line wiring by C6.

IF amplifier operates at 470kc/s. Secondary L13, C15 of IFT1 feeds signal, AVC voltages and a small standing bias decoupled by R8, C16 to g1 of IF amplifier V2. Cathode is connected down to earth line. Screen (g2) voltage is obtained from R7 and decoupled by C17. Suppressor (g3) is used for AVC purposes. Primary L14, C21, of IFT2 is in the anode circuit.

Signal rectifier.—Secondary L15, C22 of IFT2 feeds signal to diode of V2. R13 the volume control is its load resistor and R14, C19, C23, form an IF filter.

AVC is obtained by feeding the rectified signal through R10 to the suppressor (g3) of V2, which is maintained, by grid current flow through R9, at approximately earth potential. When rectified signal on diode side of R10 exceeds a critical voltage, current will flow through R10 and the negative potential is applied by R11 to g1 of V1 and by R8 to g1 of V2.

Pickup.—Sockets are fitted for connection of a high-resistance pickup. Signal from pickup is fed through isolating capacitors C24, C25 to earth line and to S5, which is ganged to the wavechange switches S1 to S4. When S5 is switched to Gram position pickup signal is fed through secondary L13 of IFT1 to g1 of V2. After amplification the audio signal is taken off the screen (g2) resistor R7 and fed through C20 to S6 and thence to volume control R13.

Screen decoupling capacitor C17 is of lower value than usual in order not to have any effect on the audio voltages developed across R7. When wavechange switch is in Gram position the aerial, g1 and oscillator anode of V1 are effectively earthed through their respective coupling capacitors.

Output stage.—C26 feeds signal from volume control R13 through stopper resistor R16 to g1 of pentode output valve V3. Cathode is connected down to earth line and bias, provided by R20 decoupled by C31 in the negative HT return to earth line, is fed through R15, R16 to g1. Screen (g2) voltage is obtained from HT line to V1 to V3. Primary L16 of output matching transformer OPI is in the anode circuit, the HT for which is obtained from junction of R18, R19. C29 gives fixed and R17 with C28 gives variable tone control.

Secondary L17 feeds signal to a 6½ in. PM loudspeaker L18. Sockets are fitted on L17 for connection of a low-impedance type extension speaker.

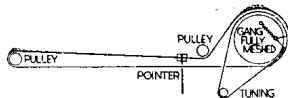

HT is provided by an indirectly heated half-wave rectifier V4. Its anode voltage is obtained from the mains direct in the case of 230-250V supplies and through auto-transformer MT1 on 100-110, 200-220V supplies. R18, R19, C32, C33, C34 give resistance-capacity smoothing. C27 gives HF filtering and C30 eliminates modulation hum.

R20, decoupled by C31 in the negative HT return-to-earth line of receiver, provides bias for g1 of V1, V2, V3.

Heaters of V1 to V4 are connected in series across a section of auto-transformer MT1.

Dial lights are connected in series across tapings on MT1.

Auto-transformer MT1 is tapped for inputs of 100-110, 200-220, 230-250V 50c/s. S7, ganged to the tone control spindle, is ON/OFF switch.

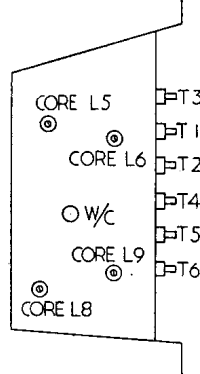

TRIMMING INSTRUCTIONS

| Apply signal as stated below | Tune receiver to | Trim in order stated for max. output |
|--|-----------------------------|---|
| (1) 470kc/s to g1 of V1 via .01 capacitor | Gang fully meshed | Core L15, L14, L13, L12 |
| (2) 470kc/s to AE and E sockets via dummy aerial | — | Core L1 for minimum |
| (3) With gang fully closed datum line on dial | Adjust dial back plate | Pointer to coincide with |
| (4) 6mc/s as in (2) | 50 metres | Core L11, L7 |
| (5) 23.1mc/s as above | 13 metres | T6, T3. Use second peak from maximum capacity setting of T6 |
| (6) Repeat operations put is obtained at both settings | (4), (5) until maximum out- | put is obtained |
| (7) 600kc/s as above ... | 500 metres | Core L9, L6 |
| (8) 1.5mc/s as above ... | 200 metres | T5 |
| (9) 1.4mc/s as above ... | 215 metres | T2. Repeat (7), (8), (9) until maximum output is obtained |
| (10) 166.6kc/s as above | 1800 metres | Core L8, L5 |
| (11) 300kc/s as above | 1000 metres | T4, T1. Repeat (10), (11) until maximum output is obtained |

DENCO DENCADET

Contd. from page 31

AERIAL.—For reception of the more powerful stations an aerial consisting of approximately 11½ feet of insulated wire is permanently attached to the receiver. A clip fitted to the end of the wire enables an external aerial to be used when desired. An earth wire isolated from the chassis by capacitor C3 is also provided.

Signal from aerial is fed through isolating capacitor C1 to S1 and thence switched to coupling coils L2 (MW) and L4 (LW). L1 is a series filter choke for the LW band. The grid coils L3 (MW), L5 (LW) are switched by S2 to aerial tuning capacitor VC1 and to g1 of triode-hexode frequency changer V1.

T1 is MW variable trimmer and C4 a fixed LW trimmer. S3 short circuits L5, C4 when receiver is operating on MW band. AVC decoupled by R4, C2 is fed through the tuned coils and S2 to g1. Cathode is connected down to chassis. Screen (g2, g4) voltage is obtained from R1. L10, C5, which form the primary of IFT1, are in the hexode anode circuit.

Oscillator is connected in a grid-tuned, shunt-fed circuit. The grid coils L6 (MW), L8 (LW), which are padded by C10, C9 respectively, are switched by S5 to tuning capacitor VC2 and coupled by C7 to oscillator grid (gt. g3) by V1. T2 is MW variable trimmer and C8 fixed LW trimmer. S4 connects top of L8 down to AVC line to damp LW oscillatory circuit when receiver is switched to MW range. Automatic bias for grid is developed on C7, with R2 as leak resistor.

Anode reaction voltages are obtained inductively on L7 (MW), L9 (LW) and are switched by S6 through C11 to oscillator anode of V1. R1 is oscillator anode load.

IF Amplifier operates at 465 kc/s. Secondary L11, C6 of IFT1 feeds signal and AVC voltages to g1 of pentode section of V2. R4, C2 decouple the AVC line, Cathode and suppressor (g3) of V2 are connected down to chassis. Screen (g2) voltage is obtained from R3 and decoupled by C12. Primary L12, C16 of IFT2 is in the anode circuit.

Signal Rectifier.—Secondary L13, C17 of IFT2 feeds signal diode of V2. R5, R6 form a tapped diode load and C13 is an RF filter capacitor.

AVC.—The DC component of the rectified signal is used to provide the AVC voltage. The DC component is potentially divided by R5, R6 and approximately one third of the available voltage is fed by R4 to control grids (g1) of V1, V2. Decoupling is given by R4, C2.

Output Stage.—C14 feeds rectified signal to volume control R7 and thence it is fed through stopper R8 to pentode output valve V3. Cathode bias is provided by R9 decoupled by C19. Screen voltage is

Shunt-wound Dynamo

A SHUNT-WOUND 3kW 6V dynamo was intended to supply 500A to an electro-deposition vat but from installation the full output was unobtainable. Speed was correct.

It was noticed that the shunt filled regulator was connected to the dynamo by a few yards of 3/0.036 VIR cable in conduit. Whilst this cable would have been suitable for a 3kW dynamo of medium voltage,

obtained from R10 and decoupled by C18. R10, C18 also act as voltage dropper and decoupling for HT supply to V1, V2.

Primary L14 of output matching transformer OPI is in the anode circuit of V3, the HT for which is obtained direct from reservoir smoothing capacitor C20. C15 gives high-frequency tone correction. Secondary L15 of OPI feeds signal to a 5in. PM loudspeaker L16.

High Tension is provided by an indirectly heated half-wave rectifier V4 with anode voltage obtained from the input mains direct, in the case of 195 of 225V supplies, and through dropper resistor R11 for 225 to 250V supplies.

Smoothing is given by R10 with C18, C20.

Heaters of V1 to V4 are series connected and obtain their current of 100mA from the mains through tapped dropper resistor formed by R11, R12.

S7 which is the mains lead to chassis and ganged to the volume control spindle, is the ON/OFF switch. The other mains lead is fitted with a 500mA fuse. C21 is a mains filter capacitor.

Chassis Removal.—Remove the control knobs, rear and base panels.

Remove the six wood screws, securing the top and bottom edges of chassis to inside of cabinet.

Lift chassis sufficiently to allow smoothing capacitor (C18, C20) to clear the LS magnet. It will be necessary to press down the paxolin strip on which is mounted R10 so as to give additional clearance. With the chassis lifted swing it diagonally to the right and withdraw. If the LS leads are unsoldered from OPI then the chassis can be completely separated from the cabinet. To expose the entire underneath of the chassis the dial plate must be removed by unscrewing the four bolts holding it in position.

When replacing chassis in cabinet check to see that R10 is repositioned correctly and also that unit C18, C20 has not been displaced so that its live tags are touching the volume control connections.

TRIMMING INSTRUCTIONS

| Apply signal as stated below | Tune receiver to | Trim in order stated for max. output |
|--|------------------|--------------------------------------|
| (1) 465 kc/s to g1 of V1 via .01mF. | — | Core L13, L12, L11, L10. |
| (2) 1.450 mc/s to AE lead via dummy aerial | 1.45 m/cs | T2, T1. |
| (3) 570 kc/s as above | 570 kc/s | Core L6, L3, and repeat (2) & (3) |
| (4) 165 kc/s as above | 165 kc/s | Core L8, L5. |

it was evident that the cable had too high a resistance for this low-voltage dynamo, which would require many amperes shunt field current.

After the fitting of larger cables between the field regulator and dynamo it was possible to increase the terminal voltage of the dynamo to 7.5 although the load current was rather less than the rated full load value. The current was increased to the required value however, by increasing the concentration of the solution, thus lowering the resistance.—J.L.W.