

**AnyTone®**

**AT-5555 PLUS  
AT-5555 PLUSIN**

**10 METER RADIO  
Instruction Manual**





## CONGRATULATIONS FOR YOUR CHOICE!!!

The ANYTONE brand has always wanted to identify itself with a highly technological profile, applying the most modern and efficient design criteria with expertise. The aim of all this is to offer innovative, exclusive and efficient solutions. The new AT-5555 PLUS and AT-5555 PLUS / N models are the latest results of what has been written: they ensure you exceptional performance for comfortable use, reliable operation and exciting horizons. The skilful use of the SMT technology guarantees you the best stability, reliability and unprecedented quality. Your multimode AT-5555 radio is a further step in amateur radio telecommunications: it is certainly the most appropriate partner for the exceptionally demanding users. In addition, the multi-ports connection available in the device make it ready for easy upgrades and related function extensions. To ensure optimal use of the radio, we recommend that you read this user manual carefully before installing and activating the device.

---

---

# CONTENTS



<b>FUNCTIONS &amp; FEATURES</b> .....	<b>1</b>
<b>WARNING</b> .....	<b>1</b>
<b>RESET FUNCTION (Resume Factory Default)</b> .....	<b>1</b>
<b>INSTALLATION</b> .....	<b>2</b>
<b>HOW TO USE YOUR RADIO</b> .....	<b>4</b>
<b>FUNCTION MENU SETUP</b> .....	<b>9</b>
<b>SPECIFICATIONS</b> .....	<b>12</b>



## FUNCTIONS & FEATURES

1. Large LCD panel which displays frequency and all kinds of information
2. DUAL-DIGITAL TUBE FOR CHANNEL DISPLAY
3. USE EL technology for backlight
4. PA, CW, AM, FM, USB, LSB mode
5. A, B, C, D, E, F, 6 banks in total, where 60 channels at least can be individually programmed.
6. Frequency Tuning Step can be 10HZ, 100HZ, 1KHZ or 10KHZ.
7. Multiple CLARIFIER Operating Modes
8. Flexible menu functions and PC programming software to meet varied customer demands
9. ECHO Function
10. SQ, ASQ Function (FM and AM mode only)
11. RF GAIN ADJUSTMENT
12. RF PWR ADJUSTMENT
13. SCAN FUNCTION
14. RB FUNCTION
15. NB/ANL FUNCTION
16. DW DUAL-WATCH FUNCTION
17. BEEP VOICE PROMPT
18. +10KHZ Function
19. SWR, S/RF, DC Voltage display function
20. TOT function
21. HI-CUT FUNCTION
22. EMG CALL
23. SWR PROTECTION
24. POWER SUPPLIED VOLTAGE PROTECTION

25. Key-Lock Function
26. VOX function
27. CTCSS/DCS code
28. RX compander: noise blanker
29. Noise gate setting: mic noise adjustable
30. RX Noise Reduction (only AT-5555PLUS/N)
31. Compatible with "electronic" and "dynamic" MIC type

## WARNING

To use the radio, please connect the antenna to the jack "B" on the back panel of the equipment firstly and then measure the SWR (Standing Wave Ratio) before transmitting (at this subject read the chapter nr.5/ page 3). A badly tuned antenna can destroy the final TX amplifier, these components are NOT covered under warranty.

## RESET FUNCTION (Resume Factory Default)

This Radio offers the RESET FUNCTION to prevent and solve accidental upgrading, as well as provides a solution for customers who changed or activated unconsciously some unwanted function: the resuming of the original "factory setting" is easy and instantly.

### How to Operate:

**Step 1:** Power off the radio.

**Step 2:** Press and hold FUNC and SCAN keys at the same time, followed by powering on the radio.

**Step 3:** Release the two keys when LCD displays "RES".

All former settings would be replaced by Factory Default value when LCD displays "REND".

**WARNING:** All former settings would be replaced by Factory Default value after operating the RESET FUNCTION.

## INSTALLATION

## 1. WHERE AND HOW TO MOUNT YOUR RADIO

- a) It is important to identify the proper place of the installation by considering "key criteria", such as easy access and congenial spaces with freedom of movement.
- b) The radio must not compromise the comfort of either: the driver and the passengers.
- c) Remember to provide cables in harmony with safety and prevention "standards". As well as guides their wiring in protected channels (eg: power supply, antenna, accessory wiring), so that they do not interfere in any way with the driving of vehicles.
- d) To install your equipment, use the bracket (1) and the self-tapping screws [2] provided (drilling diameter 5 mm). Be careful not to damage the vehicle's electrical system when drilling the dashboard.
- e) Do not forget to insert the rubber joints [3] between the radio and its bracket as they have a cushioning effect that allows a delicate orientation and tightening of the device.
- f) Choose where to place the microphone holder and remember that the microphone cable must extend to the driver without interfering with the vehicle's controls.

## 2. ANTENNA INSTALLATION

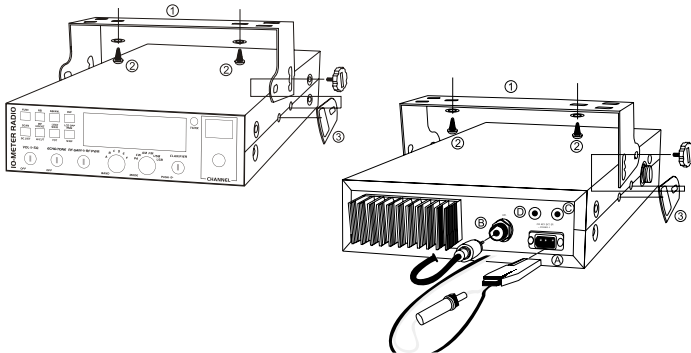

### a) Antenna selection:

For the best signal radiation, a well-calibrated antenna length is very important, on the other hand, there are other factors to be considered: the size of the vehicle and its usual speed. For this subject you can recall for the support and patronage of your dealer.

### b) Mobile antenna:

-Must be fixed to the vehicle where there is a maximum of metallic surface (ground plane), away from windscreen mountings.

-There are two types of antenna: Pre-Regulated Antenna which should be used on a good ground plane (e.g. car roof or lid of the boot), and Adjustable Antenna which offer a much wider frequency range and can be used over a smaller ground plane.

For an antenna which must be fixed by drilling, you will need a good contact between the antenna and the ground plane. To obtain this, you should lightly scratch the surface where the screw and tightening star are to be placed.

-Be careful not to pinch or flatten the coaxial cable (as this runs the risk of break down and/or short circuiting).

-Connect the antenna to location (B).

### c) Fixed antenna:

A fixed antenna should be installed in a predominant area, possibly emerging over the entire surrounding topography, including the canopies of trees. Normally the antenna is raised up and fixed on the top of a mast. In some areas, especially urban ones, it may be necessary to observe the regulations in force in the specific region. In order to avoid unnecessary inconvenience, it is advisable to check this matter with the authorities entrusted.

## 3. POWER CONNECTION

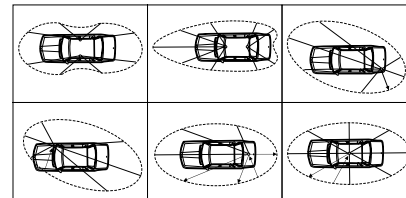

Your RADIO is protected against an inversion of polarities. However, before switching it on, you are **requested** to check all the connections. Your equipment must be supplied with a **voltage of 12 volts DC(Direct Current)**. Today, most cars and **trucks** are negative earth. You can check this by making sure that the negative terminal of the battery is connected either to the engine block or to the chassis. If this is not the case, you should consult your dealer.

**WARNING:** **trucks** generally have two batteries to supply a voltage of 24 volts, in which case it will be necessary to insert a 24/12 volt **inverter** into the electrical circuit. The following connection steps should be carried out with the power cable disconnected from the set.

- a) Check whether the battery is of 12 volts.
- b) Locate the positive and negative terminals of the battery (+ is red and - is black). Should it be necessary to lengthen the power cable, please use the same or a superior type of cable.
- c) It is necessary to connect your radio to a permanent (+) and (-). We advise you to connect the power cable directly to the battery (as the connection of the cable to the wiring of the car-radio or other parts of the electrical circuit may, in some cases, increase the possibilities of interference).
- d) Connect the red wire (+) to the positive terminal of the battery and the black (-) wire to the negative terminal of the battery.
- e) Connect the power cable to your radio.

**WARNING:** Never replace the original fuse (10A) by one of a different value.

#### 4. BASIC OPERATIONS TO BE CARRIED OUT BEFORE USING

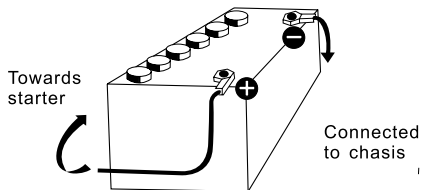

**YOUR SET FOR THE FIRST TIME** (without transmitting or using the <<Push-To-Talk>> switch on the microphone)

- a) Connect the microphone
  - b) Check the antenna connections
  - c) Turn the set on by turning the volume knob clockwise
  - d) Turn the squelch knob to minimum
  - e) Adjust the volume to a comfortable level
  - f) **Tune to channel 20 at the D bank** by using either the UP or DN key on the microphone or the rotary knob.

#### 5. ADJUSTMENT OF SWR(standing wave ratio)

**WARNING:** This **process** must be carried out when you use your radio for the first time (and whenever you re-position your antenna). The adjustment must be carried out in an obstacle-free area.

##### Adjustment with a built-in SWR meter or external SWR meter

- a) To connect the SWR meter
 

Connect the SWR meter between the radio and the antenna as close as possible to the radio (use a maximum of 40cm cable).
- b) To adjust the SWR meter
  - Set **the radio to channel 20 at the D bank** in FM.
  - Slide** the switch on the SWR meter to position CAL or FWD.
  - Press the <<Push-To-Talk>> switch on the microphone to transmit.
  - Adjust** the index needle **over ▼ sign** by **rotating** the calibration knob.
  - Change the switch to position SWR (reading of the SWR level). The reading on the meter should be as near as possible to 1. If this is not the case, re-adjust your antenna to obtain a reading as close as possible to 1.( An SWR reading between 1 and 1.8 is acceptable).
  - It will be necessary to re-calibrate the SWR meter after each adjustment of the antenna.

#### 6. HOW TO USE AN EXTERNAL SWR METER

- Set to channel 20 on D bank in FM.
- Press <<push-to-talk>> button on the microphone to transmit.
- At the moment, LCD would display SWR value which should be as close as possible to 1. If this is not the case, re-adjust your antenna to obtain a SWR value as close as possible to 1 (an SWR reading between 1 and 1.8 is acceptable).

## ■ HOW TO USE YOUR RADIO

### <LCD Display>

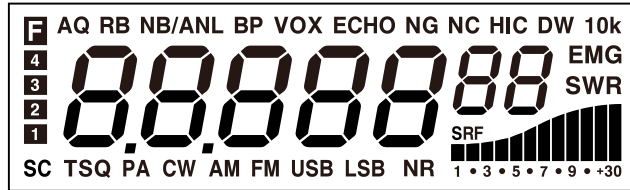

- 7 digits:** Display frequency and any other information.
- Indicating bars:** Indicate RX, RSSI, PA, PWR, SWR.
- The first decimal point:** Appears when current channel is edited with SCAN DEL.

- F:** Appears after pressing FUNC key.
- AQ:** Appears when ASQ function is started (only for AM/FM).
- RB:** Appears when Roger beep function is started (enabled).
- NB/ANL:** Appears when NB/ANL function is started (enabled).
- BP:** Appears when BP function is started (enabled).
- ECHO:** Appears when ECHO function is started (enabled).
- VOX:** Appears when VOX function is started.
- NG:** Appears when TX noise gate is started.
- NC:** Appears when RX noise compander is started.
- HI-CUT:** Appears when HI—CUT function is started.

- DW:** Appears when DW function is started.
- 10K:** Appears when +10KHZ function is started.
- EMG:** Appears when EMG channel is used.
- SWR:** Appears when SWR is used.
- SRF:** Appears when S/RF is used.
- SC:** Appears when SCAN is used.
- TSQ:** Appears when CTCSS/DCS code is used.
- NR:** Appears when RX noise reduction is turn on.
- PA, CW, AM, FM, USB, LSB:** Indicate different operating modes.

1. Appears when CLARIFIER function is FINE operation.
2. Appears when CLARIFIER FUNCTION is COARSE operation or RT operation.
3. Appears when CLARIFIER FUNCTION is transmitting frequency regulated.

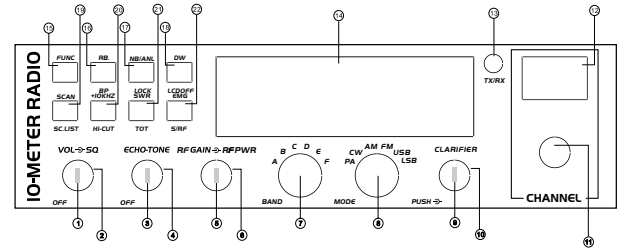

### <FRONT PANEL>

- 1. OFF/ON/VOLUME (Inner Dual Concentric)**  
Turn clockwise to switch on the radio and set desired volume level. Under normal operating state, the VOLUME control is used to adjust the output volume obtained either by the transceiver speaker or the external speaker or the external PA speaker, if used.
- 2. SQUELCH (Outer Dual Concentric)**  
This control is used to cut off or eliminate receiver background noise in the absence of an incoming signal. For maximum receiver sensitivity,

it is desired that the control be adjusted only to the point where the receiver background noise or ambient background noise is eliminated. Turn fully anticlockwise then slowly clockwise until the receiver noise disappears. Any signal to be received must now be slightly stronger than the average received noise. Further clockwise rotation will increase the threshold level which a signal must overcome in order to be heard. Only strong signals will be heard at a maximum clockwise setting.

### 3. ECHO(Inner Dual Concentric)

This switch is used to control echo effect.

### 4. TONE (Outer Dual Concentric)

This switch is used to control intervals of echo sound

### 5. RF GAIN ( Inner Dual Concentric)

This switch is for adjusting sensitivity during reception. For long distance communications **RF GAIN** should be set to maximum. **RF GAIN** can be reduced to avoid distortion, when your correspondent is close by and when he does not have **RF POWER**. The normal setting of this function is on maximum (fully clockwise).

### 6. RF POWER (Outer Dual Concentric)

Adjustment of the output power is for AM and FM mode only. Reducing the power is allowed when communicating with a person who has no **RF GAIN**. The normal position of this function is set to maximum, fully clockwise.

### 7. BAND SELECTOR

Rotate this switch to select A, B, C, D, E, F band of operation

### 8. MODE(PA/CW/AM/FM/USB/LSB)

This switch allows selecting the modulation mode PA, CW, AM, FM, LSB or USB. Your modulation mode has to correspond with the one of your correspondent. The mode selector changes the mode of operation of both transmitter and receiver simultaneously.

**Frequency Modulation/FM:** for nearby communications on a flat

open field.

**Amplitude Modulation/AM:** Communication on a field with relief and obstacles in middle distance (the most used).

**Upper and Lower Side Band/USB-LSB:** Used for long distance communications (according to the propagation conditions).

### 9. CLARIFIER

This is frequency tuning knob which can be set as different modes (refer to CLA Specifications in Functions Menu for more details).

### 10. PUSH

This is PUSH Key which can be set as different modes (refer to PSH specifications under Functions Menu for more details).

### 11. CHANNEL SELECTOR

Rotate this switch to select any desired channel from forty citizens band channels. The selected channel appears on the LED directly above the channel selector knob.

### 12. CHANNEL INDICATOR

Numbered LED indicates the selected channel to operate on.

### 13. RECEIVER/TRANSMIT INDICATOR

When it is receiving, the LED will be green. The LED will be red when it is transmitting.

### 14. LCD DISPLAY

Display frequency, all kinds of information and icons.

### 15. FUNC

This is functional key. Press and hold this key for 2seconds to enter into Functions Menu Setup (refer to Functions Menu for more details). Press FUNC key and other individual key to realize the second functions silk-screened under the button. For example, press FUNC key followed by pressing RB key to realize the BP function. Press FUNC key followed by DW to realize the LCD OFF function.

**Details operations are as follows:**

Press FUNC key, "FUNC" icon will appear on LCD display. Release



---

---

FUNC key, and then press other keys to realize the second functions silk-screened under the button. "FUNC+ Keypad name" is to be used in the following operating instruction.

#### **16. ROGER BEEP OR BEEP FUNCTION**

##### **(1) RB**

Press "RB" key to enable "ROGER BEEP" function with "RB" icon appearing on LCD display. Press the key repeatedly to switch on/off the function.

When RB function is enabled, the radio will automatically transmit the audio signal at the end of your transmission. The listener can note easily that your transmission is over through the signal.

##### **(2) FUNC+RB**

Press FUNC+RB to realize BP Function. It is a prompting function with "BP" icon appearing on LCD display. Speaker would emit a BEEP for prompting when press any key. press FUNC+RB repeatedly to switch on/off the function.

#### **17. NB/ANL or LOCK**

(1) Press NB/ANL key to enable NB/ANL function with "NB/ANL" icon appearing on the LCD display. Press the key repeatedly to switch on/off the function.

Noise Blanker/Automatic Noise Limiter. These filters allow reducing back ground noises and some reception interferences.

##### **(2) FUNC+NB/ANL**

Press FUNC+NB/ANL to realize the Keyboard Lock function. When this function is enabled, all keys are invalid except PTT, BAND SWITCH, and MODE SWITCH. When pressing any key except PTT, BAND SWITCH, MODE SWITCH, the LOCK icon will display on the LCD. These situations indicate that the keyboard has been locked. Press FUNC+NB/ANL repeatedly to switch on/off the function.

#### **18. DW or LCD OFF**

(1) The DW (dual watch) function allows automatic alternate monitoring of two channels. Refer to the following procedures to

enable this function.

To enable the DW function, firstly turn the SQ control clockwise until the background noise is cut out. Select the first channel to be monitored by using the CHANNEL SELECTOR knob or the channel selector keys on the microphone. Press the DW key and the DW icon will flash on the LCD display. Secondly, follow the above procedures to select second channel to be monitored. Finally, press the DW key again and the two monitoring channels will be alternately indicated on the LCD. Radio will automatically start monitoring (scanning) the two channels. When a signal is detected on one of the channels, scanning stops and it is possible to listen the communications on that channel. Press PTT to transmit on this channel. If there is no transmission or detected signal on that channel within 5 seconds(time to resume scanning can be programmed by PC software), radio will resume scanning. When the DW function is enabled, the DW icon appears on the LCD. To exit the DW function, press the DW key or the PTT key.

The scan Type above is the SQ mode under SCA Selection in Function Menu. If TI mode is selected and valid signal is detected, the radio would still start scanning when it is time to resume scanning, whether there is signal or not in current channel.

##### **(2) FUNC+DW**

When this function is enabled, LCD display would be switched OFF(LCD OFF).

Repeat this operation to switch ON/ OFF the function.

#### **19. SCAN OR Scan.list**

##### **(1) SCAN**

Automatic Scanning of busy channels.

Press the SCAN key to enable the SCAN function. Before enabling the SCAN function, firstly turn the SQ control clockwise till the background noise is cut out. Then press the SCAN key, radio will automatically scan all channels continuously in the scan list and the SC icon will appear on the LCD.

When a signal is detected on a channel, scanning stops on this

channel. You can receive the calling, and also, can transmit on this channel by pressing PTT key. If there is no transmission or detected signal on that channel within 5 seconds(time to resume scanning can be programmed by PC software), radio will start scanning again. To exit the SCAN function, press the SCAN key or the PTT key.

The Scan Type above is the SQ mode under SCA Selection in Function Menu. If T1 mode is selected and valid signal is detected, the radio would still start scanning when it is time to resume scanning, whether there is signal or not in current channel.

#### (2) FUNC+SCAN

SC.LIST (Scan ADD or Delete). Press FUNC+SCAN to delete current channel from scan list. The first digit on LCD would display. When Scan function is enabled, the radio would skip the deleted channel. Repeat this operation to Add or Delete channels from scan list.

#### 20. +10KHZ or HI-CUT

(1) +10KHZ Press this key to shift frequency up by 10khz.

When pressing this key, 10KHZ would appear on LCD and frequency of channels is shifted up by 10 KHZ. Repeat this operation to switch ON/OFF this function.

(2) FUNC+ +10KHZ

Press FUNC+10KHZ to realize HI-CUT function. Once this function is enabled, the radio would cut out high frequency interference. Its use depends on reception conditions.

When this function is enabled, "HI-CUT" would appear on LCD. Repeat this operation to switch ON/OFF the function

#### 21. SWR OR TOT

(1) SWR

When pressing this key, "SWR" icon would appear on the LCD. When transmitting, SRF bars indicate SWR value other than PA or PWR value. One bar displaying on the LCD indicates that SWR value is 1.0. Each additional bar indicates every 0.1 added value. Repeat this operation to switch ON/OFF the function.

(2) FUNC+ SWR

When pressing this key, TOT ON or TOT OFF would display on the LCD for 2 seconds. Repeat this operation to switch ON/OFF the function. When ON appears on the LCD, users can press PTT to transmit. Then, the radio would time the transmitting duration. Once the duration is beyond the set TOT time (programmable), the radio would emit voice prompt and stop transmitting and back to receiving state automatically. This function aims to protect the radio against power tube damage from superheating caused by long transmission.

#### 22. EMG OR S/RF

(1) EMG realizes Emergency Channel Call. When emergent situation happens, the radio would switch to the channel set in advance to communicate immediately. Then the "EMG" icon would display on the LCD . Press EMG key again to return to previous channel.

(2) FUNC + S/RF

S/RF is the switch of TX's or RX's S/RS indicating bar. When this function is enabled, "SRF"icon would display on the LCD. Repeat the this operation to switch ON/OFF the function.

#### <Rear Panel>

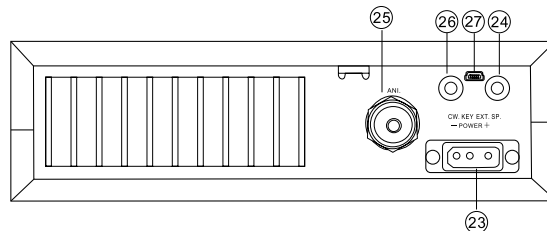

#### 23. POWER

Accept 13.8V DC power cable with built-in fuse (10 Amp) to be connected.

## 24. EXT SP or PA SP

### EXT SP

Accept 4 to 8 ohm, 4 watt external speaker to be connected. When external speaker is connected to this jack, the built-in speaker is automatically disconnected.

### PA SP

It is used to connect a PA speaker. Before operating PA, you must firstly connect a PA speaker to this jack.

## 25. ANTENNA

Accept 50 ohm coaxial cable with a type PL-259 plug to be connected.

## 26. CW KEY

This jack is for Morse code operation; To operate, connect a CW key to this jack and place the MODE switch in the CW position (LCD display icon "CW")

## 27. CW KEY

\*PC connection for software programming.

## <PRESS—TO—TALK—MICROPHONE>

The receiver and transmitter are controlled by the Press-To-Talk switch on the microphone.

Press the switch to transmit and then release it to receive. When transmitting, hold the microphone two inches from the mouth and speak clearly in a normal "voice". The radios come complete with low-impedance (150 ohm) dynamic microphone.

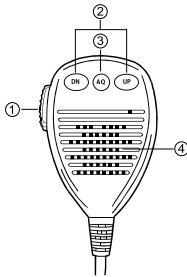

## 1. PTT

Transmitting key, Press to speak and release to receive a message.

## 2. UP/DN

These key allow increasing or decreasing a channel number.

## 3. AQ

(1) When the radio is receiving a call, press this key to enable ASQ (Automatic Squelch Control) function. Then, "AQ" would appear on the LCD. Press this key repeatedly to switch on/off the function.

(2) When the radio is receiving a call, press and hold this key for over 2 seconds to enable signal monitoring function. At the moment, whether the radio receive signal or not, the radio would detect current channel to check whether current channel has weak signal. Release AQ key to exit this function.

(3) Pressing PTT and AQ key at the same time, the radio would emit a single-tone. This tone is to help and remind two sides of communication to adjust frequency. The frequency of this tone is adjustable.

(4) ASQ (Automatic Squelch Control)

ASQ control setting. It has same function with AQ button on the microphone.

## 4. MICROPHONE

The radios come complete with low-impedance (150 ohm) dynamic microphone.

## FUNCTION MENU SETUP

The initial functions and parameter can be changed via the following settings and operations. Please read the following instruction before making any desired amendments.

To enter Function Menu: under ON state, press and hold FUNC key for more than 2seconds, and then release the FUNC key to enter into the Function Menu Setup. Under this condition, press FUNC key to select different functions menu, CHANNEL SELECTOR Switches to change the data of Function Menu.

### (01) ICG

This menu refers to MIC GAIN function. Users can set the value by software. The higher value goes to higher sensitivity. 64 grades in total (OFF,0-63)

**Default:** 41

### (02) UOL

This menu controls the VOX sensitivity from level OFF to 9.

**Default:** OFF

### (03) UOT

This menu controls the VOX delay time from level 1 to 9.

**Default:** 04

### (04) RCDT

This menu refers to RX CTCSS and DCS code setting.

**Default:** OFF

### (05) TCDDT

This menu refers to TX CTCSS and DCS code setting.

**Default:** OFF

### (06) NC

This menu refers to RX noise compander setting.

**Default:** OFF

### (07) NG

This menu refers to TX noise gate setting.

**Default:** OFF

### (08) NR(only for model AT-5555 PLUS/N)

This menu refers RX noise reduction setting

**Default:** OFF

### (09) ICP

This menu refers to microphone type setting.

**EL:** electronic type, **DY:** dynamic type

**Default:** OFF

OFF 改为 DY

### (10) NOG

It refers to TX MON function. Users can set the volume and grade of the TX MON by software. The higher grade goes to louder TX MON.

64 grades in total (OFF,0-63)

**Default:** OFF

### (11) CSU

This menu is to adjust the side voice of CW SIDE VOL CW. 64 grades in total.

**Default:** 31

### (12) BEU

This menu is to set the volume of prompt voice. 64 grades in total(OFF,0-63).

**Default:** 31

### (13) STP

This menu is to set tuning step when adjusting frequency by CLARIFIER knob

**Options:** 10Hz、100Hz、1KHz、10KHz

**Default:** 10Hz

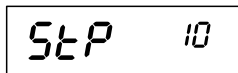
The LCD display shows the text "STP 10" in a digital font. "STP" is on the left and "10" is on the right.

### (14) CLA

This menu is to

set functions turned by CLARIFIER knob.

Options are as follows:

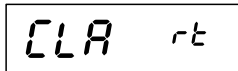
The LCD display shows the text "CLA rt" in a digital font. "CLA" is on the left and "rt" is on the right.

**FIN:** Fine regulation. When this option is selected, users can fine tuning the receiving frequency by rotating the CLARIFIER knob. In tuning process, the transmitting frequency can not be regulated by the knob and "1" icon will appear on the LCD.

**RT:** When this option is selected, users can regulate the frequency of both transmitting and receiving. In tuning process, "2" icon will appear on the LCD.

**T:** When this option is selected, users can only regulate the transmitting frequency. In tuning process, "3" icon will appear on the LCD.

**Default:** RT

### (15) PUS

This menu is to set functions realized via PUSH knob. Options are as follows:

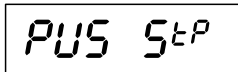
The LCD display shows the text "PUS STP" in a digital font. "PUS" is on the left and "STP" is on the right.

**COA:** When this option is selected, press PUSH and turn CLARIFIER knob to realize COARSE function.

When pressing this key, "2" icon will appear on far left of the LCD. Under this condition, rotate the CLARIFIER knob to change frequency of both transmitting and receiving.

**T:** When this option is selected, press PUSH and turn CLARIFIER knob to change transmitting frequency. When pressing this key, "3" icon will display on the far left of the LCD. Under this condition, rotate the CLARIFIER knob to change the transmitting frequency only.

**STP:** When this option is selected, PUSH function will change Frequency Tuning Step of CLARIFIER knob. Press this key, then the corresponding frequency bit would blink.

**Default:** STP

### (16) ASQ

ASQ control setting. It has same function with AQ button on the microphone.

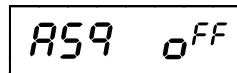
The LCD display shows the text "ASQ OFF" in a digital font. "ASQ" is on the left and "OFF" is on the right.

**Default:** OFF

### (17)TOT

This menu is to set transmitting TOT time. When pressing PTT key at a single time longer than the due time setup in advance, the radio would stop transmitting automatically and loudspeaker will emit voice prompt till PTT key is released. Then, the radio can transmit again.

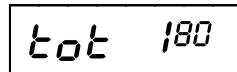
The LCD display shows the text "tot 180" in a digital font. "tot" is on the left and "180" is on the right.

**Options:** 30-600s **Step:** 30s

**Default:** 180s

### (18) SC

This menu is to set Scan Type. Options are as follows:

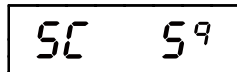
The LCD display shows the text "SC SQ" in a digital font. "SC" is on the left and "SQ" is on the right.

**SQ:** When SQ is selected, scan would stop when a valid signal is detected. The radio would resume scanning after signal disappears for 5s.

**TI:** When TI is selected, scan would stop when a valid signal is detected. The radio would resume scanning 5 seconds later, whether signal disappears or not.

**Default:** SQ

### (19) TSR

This menu is to choose whether to enable Transmitting SWR Protection function or not.

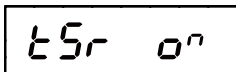

**ON:** When ON is selected, the radio will detect the SWR of antenna. Once the SWR is beyond the SWR set in advance, the radio would prohibit transmitting automatically and loudspeaker will emit voice prompt. Then, "HI S" icon will display on the LCD to remind you that the antenna SWR is too high or antenna do not connect well.

**OFF:** When OFF is selected, SWR Protection function is disabled.

**NOTE:** To protect the radio from long transmission under high SWR, the radio would automatically start SWR Protection once the SWR Value is higher than 20:1.

**Default:** ON (SWR=<10:1)

### (20) TDC

This menu is to choose whether to enable Power supplied Voltage Protection function.

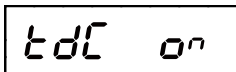

**ON:** When ON is selected, the radio will detect the supplied voltage. Once the voltage surpasses the voltage setup in advance, the radio would display "DC LO" or "DC HI" to remind you that the voltage is not in normal state. Meanwhile, the radio will prohibit transmitting and emit beep prompt.

**OFF:** When OFF is selected, the Power Supplying Voltage is disabled.

**Default:** ON (DC 10.5V-16V)

### (21) TLD

This menu is to set the content displayed on the LCD when transmitting.

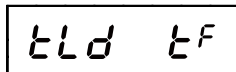

**TF:** When TF is selected, LCD would display transmitting frequency when transmitting.

**SR:** When SR is selected, LCD would display SWR value of antenna when transmitting, for example: "1.2" on the LCD.

**BAT:** When BAT is selected, LCD would display Supplied Voltage when transmitting, for example: "13.8DC" on the LCD.

**TOT:** When TOT is selected, LCD would display TOT remaining time when transmitting. And TOT would count down till remaining time is 0, for example: "170" displayed on the LCD display.

**Default:** TF

### (22) RBF

This menu is to select frequency of Roger Beep. The frequency range is 300KHz-3KHz. The shift step is 10Hz.

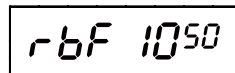

**Default:** 1050Hz

### (23) RBT

This menu is to select Roger Beep Holding Time from 50ms—1000ms. The shift step is 50ms.

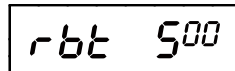

**Default:** 500ms

### (24) CFR

This menu is to select CW Side Tone Frequency from 300Hz-3KHz, the shift step is 10Hz.

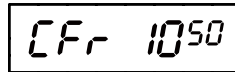

**Default:** 1050Hz

### (25) TON

This menu is to select Transmitting Single-Tone Frequency from 300Hz-3KHz. The shift step is 10Hz.

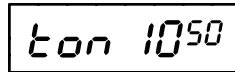

**Default:** 1050Hz

## SPECIFICATIONS

General	
Frequency Range	28.000MHz-29.700MHz
Frequency Band	A/B/C/D/E/F
Channel	60 channels (programmable) in each band
Frequency Control	Phase-Locked-Loop Synthesizer
Frequency Step	10Hz 100Hz 1KHz 10KHz
Frequency Tolerance	0.005%
Frequency Stability	0.001%
Temperature Range	-30°C to +50°C
Microphone	Plug-in dynamic; with push-to-talk /UP/DN/ ASQ switch and coiled cord
Input Voltage	DC 13.8V normal, 15.9V max; 11.7V min Transmit: AM full mod 6A Receiver: Squelched 0.8A SSB 30W PEP output 9A
Size	28*25*6CM
Weight	1.5KG
Antenna Connector	UHF,SO239
TRANSMITTER	
Power Output	AM/CW:1-12W(adjustable) FM:1-40W(adjustable) USB/LSB:1-35W(adjustable)
Modulation	High and low level class B Amplitude Modulation: AM Varied Capacitance Frequency Modulation: FM
Inter-modulation Distortion	SSB: 3rd order, more than -25dB; 5th order, more than -35dB
SSB Carrier Suppression	55dB
Unwanted Sideband	50dB

Frequency Response	AM and FM: 450 to 2500Hz
Output impedance	50ohms, unbalanced
Sensitivity	SSB: 0.25 $\mu$ V for 10dB(S+N)/N at greater than 1/2-watt of audio output. AM:1.0 $\mu$ V for 10 dB(S+N)/N at greater than 1/2watt of audio output. FM: 1.0 $\mu$ V for 20 dB (S+N)/N at greater than 1/2 watt of audio output.
Selectivity	AM/FM:6dB@3KHz,50dB @9KHz SSB: 6 dB@2.1KHz,60dB @3.3KHz
Image Rejection	More than 65dB
IF Frequency	AM/FM: 10.695 MHz 1st IF, 455 KHz 2nd IF SSB: 10.695 MHz
Adjacent-Channel Rejection	60dB AM/FM &70 dB SSB
RF Gain Control	45 dB adjustable for optimum signal reception
Automatic Gain Control(AGC)	Less than 10 dB change in audio output for inputs from 10 to 100,000 microvolt.
Squelch	Adjustable; threshold less than 0.5 $\mu$ V. Automatic Squelch Control(only AM/FM) 0.5 $\mu$ V
ANL	Switchable
Noise Blanker	RF type, effective on AM/FM and SSB
Audio Output Power	4 watts into 8 ohms
Frequency Response	300 to 2800 Hz
Built-in Speaker	8 ohms, round.
External Speaker(Not Supplied)	8 ohms; disables internal speaker when connected.





***AnyTone***<sup>®</sup>

Qixiang Electron Science & Technology Co., Ltd.

**[www.anytone.net](http://www.anytone.net)**